

Risposta dinamica

Tempo di risposta	< 5 ms
Tempo di ciclo	< 50 Hz

Protezione standard

IP 65	
-------	--

Connessioni elettriche

Cavo 1.5 m	IP 65
Connettore DIN EN 175301-803-A	IP 65
Connettore DIN EN 175301-803-C (Standard industriale 9.4 mm)	IP 65
Connettore M12x1	IP 65

Connessioni di pressione

Filetto interno	G ¼ con Guarnizione O-Ring
	¼ -18 NPT
Filetto esterno	G ¼, Tenuta posteriore, DIN 3852-E
	R ¼ da EN 10226
	G ¼, Tenuta posteriore tipo manometro (kombi)
	G ½, Tenuta posteriore tipo manometro (kombi)

Posizione di montaggio

Qualsiasi	Raccomandazione: Connessione di Pressione verso dietro
-----------	--

Conformità / Certificazioni

Compatibilità elettromagnetica	Conformità CE secondo la EN 61326-2-3
--------------------------------	---------------------------------------

Peso

Con Filetto interno	~ 95 g
Con Filetto esterno	~ 110 g
Con Cavo 1.5 m	~ 40 g

Imballaggio (Per cortesia specificare sull'ordine)

Imballaggio singolo in cartoni	
Imballaggio multiplo in cartoni	da 25 pezzi

Precisione

Parametri	Unità		
Tolleranza punto zero	max.	% FS	± 1.0
Tolleranza di fondo scala	max.	% FS	± 1.0
Auflösung		% FS	0.1
Somma della linearità, isteresi e riproducibilità	max.	% FS	± 0.5
Stabilità di lungo periodo DIN EN 60770		% FS	± 1.0
C.T. del punto zero ²⁾	max.	% FS/10K	± 0.4
C.T. della sensibilità ²⁾	typ.	% FS/10K	- 0.15
C.T. della sensibilità ²⁾	max.	% FS/10K	- 0.3

Condizioni di prova: 25 °C, 45% RH, Alimentazione 24 VDC
CT z.p. / CT s. -15 ... +80 °C

¹⁾ Alla pressione nominale

²⁾ C.T.= Coefficiente di temperatura

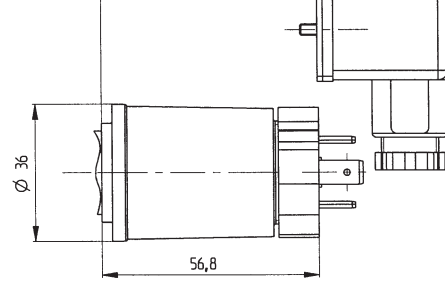
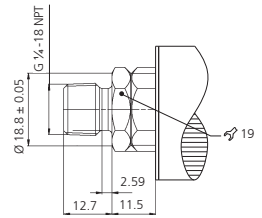
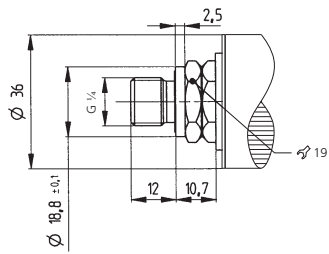

Connettore femmina
DIN EN 175301-803-A

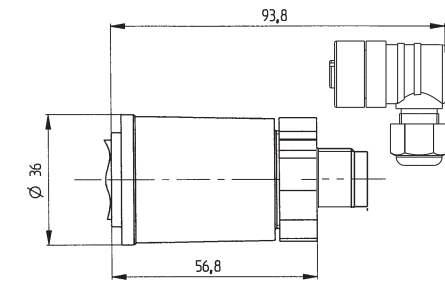
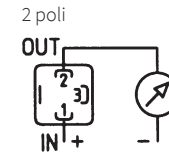
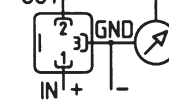

Connettore femmina
M12x1

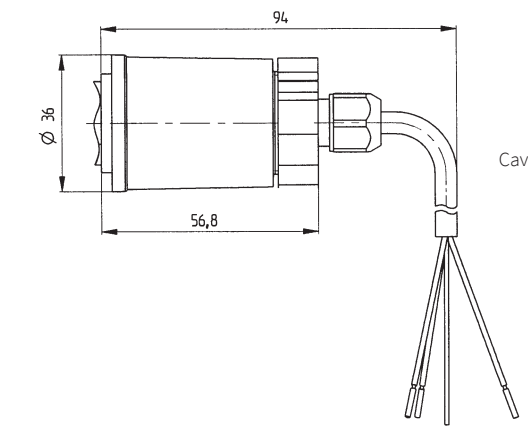
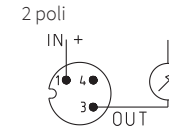
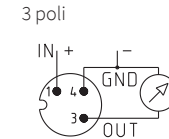

Cavo

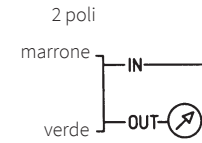
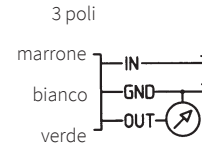

Telefono +41 56 436 82 00
Fax +41 56 436 82 82
info.ch@hubacontrol.com

Telefono +41 91 630 15 55
Telefax +41 91 630 15 22
info.it@hubacontrol.com

Huba Control AG

Niederlassung Deutschland
Schlattgrabenstrasse 24
D-72141 Walddorfhäslach
Telefon +49 7127 2393 00
Fax +49 7127 2393 20
info.de@hubacontrol.com

Huba Control AG

Vestiging Nederland
Hamseweg 20A
NL-3828 AD-Hoogland
Telefoon +31 33 433 03 66
Telefax +31 33 433 03 77
info.nl@hubacontrol.com

Huba Control SA

Succursale France
Rue Lavoisier
Technopôle Forbach-Sud
F-57602 Forbach Cedex
Téléphone +33 3 87 84 73 00
Télécopieur +33 3 87 84 73 01
info.fr@hubacontrol.com

Huba Control AG

Branch Office United Kingdom
Unit 13 Berkshire House, County Park
Business Centre, Shrivenham Road
Swindon, Wiltshire SN1 2NR
Phone +44 1993 77 66 67
Fax +44 1993 77 66 71
info.uk@hubacontrol.com

www.hubacontrol.com

