



Pressure transmitter

# Huba Control

## Relative pressure transmitter for mobile hydraulic

### Type 550



The pressure transmitter type 550 meets the highest requirements for mobile hydraulic applications. This sensor is available with protection standard IP 67 or IP 69K. The standard pressure orifice prevents damage due to pressure peaks.

The compact and rugged design meets the requirement of shock- and vibration stability according road vehicle standards ISO 16750. The pressure transmitter type 550 guarantees highest EMC stability according to various road vehicle regulations with test level up to 100V.

The measuring cell is based upon the Huba Control developed thick film technology on stainless steel and is fully hermetically welded.

**Pressure range**  
**0 ... 40 – 600 bar**

- + Compact and rugged construction for high operating reliability
- + Welded construction – no elastomer seals
- + Excellent EMC capacity
- + Negligible temperature influence on accuracy

## Technical Overview

### Pressure range

Relative 0 ... 40 – 600 bar

### Operating conditions

Medium		Liquids and gases
Temperature	Medium	-40 ... +125 °C
	Ambient	-40 ... +100 °C
	Storage	-50 ... +100 °C
Tolerable overload	≤ 400 bar 600 bar	3 x fs 2.5 x fs (max. 1500 bar)
Rupture pressure	≤ 400 bar 600 bar	6 x fs 4 x fs (max. 2500 bar)

### Materials

Case		Stainless steel 1.4404 / AISI 316 L
Plug accommodation		Polyarylamide 50% GF UL 94 V-0
Materials in contact with the medium	Pressure connection	Stainless steel 1.4404 / AISI 316 L
	Sensor	Stainless steel

### Electrical overview

	Output	Power supply	Load	Current consumption
2 wire	4 ... 20 mA	7.5 ... 33 VDC	< $\frac{\text{supply voltage} - 7.5 \text{ V}}{0.02 \text{ A}}$ [Ohm]	< 23 mA
	0 ... 5 V	7 ... 33 VDC	>10 kOhm / < 100 nF	< 7 mA
3 wire	0 ... 10 V	12 ... 33 VDC	>10 kOhm / < 100 nF	< 7 mA
	ratiom. 10 ... 90%	5 VDC ± 10%	>10 kOhm / < 100 nF	< 7 mA
Polarity reversal protection	Short circuit proof and protected against polarity reversal. Each connection is protected against crossover up to max. supply voltage.			
Insulation voltage				500 VDC

### Dynamic response

Response time	< 2 ms (10 ... 90%, typ. 1 ms)
Load cycle	< 100 Hz

### Elektrical connection

	Protection standard	Protection class
Kostal SLK 2.8 coding A	IP 69K	III
AMP-JPT	IP 67	III
AMP Superseal 1.5	IP 67	III
Deutsch DT04-3P	IP 69K	III
Deutsch DT04-4P	IP 69K	III
Metri Pack 150 P2S Series	IP 67	III
M12x1	IP 69K	III

### Pressure connection

Outside thread	7/16 - 20 UNF	sealing cone 45°
	7/16 - 20 UNF	sealed at back (SAE J514, ISO 11926-3), SAE-4 ORB with O-ring FPM (-20 ... +135 °C)
	9/16 - 18 UNF	sealed at back (SAE J514, ISO 11926-3), SAE-6 ORB with O-ring FPM (-20 ... +135 °C)
	1/4 - 18 NPT	
	G 1/4	sealed at back ISO 1179-2 (DIN 3852-E) with profile seal FPM (-30 ... +135 °C)
	G 1/8	sealed at back ISO 1179-2 (DIN 3852-E) with profile seal FPM (-30 ... +135 °C)
	M14x1.5	sealed at back ISO 9974-2 (DIN 3852-E) with profile seal FPM (-30 ... +135 °C)
R 1/4	acc. EN 10226	

### Installation arrangement

Unrestricted

### Tests / Admissions

	Noise immunity / Noise emission	Noise immunity automotive guideline
Electromagnetic compatibility	ISO 13766 - earth-moving equipment	ISO 11452-2, HF (Field), 100 V/m (200 ... 2000 MHz)
	DIN EN 13309 - construction equipment	ISO 11452-4, HF (BCI), 100 mA (20 ... 400 MHz)
	DIN ISO 14982 - agriculture and forestry	ISO 10605, ESD, ±15 kV contact, ±15 kV air
	Automotive guideline ECE R10 <sup>2)</sup>	ISO 7637-2 <sup>3)</sup> , puls 1, 2a, 2b, 3a, 3b (test level 4)
	Automotive guideline 2004/104/EG <sup>2)</sup>	ISO 16750-2, Load Dump, 155 V (1 Ω, 300 ms)
	EN 61326-2-3 - pressure transducer <sup>4)</sup>	
	EN 12895:2015 - industrial trucks	
CISPR11		
Shock acc. ISO 16750-3	50 g, 11 ms, half sine wave, 1000x / axis	
Vibration acc. ISO 16750-3	Test VI (12 g, sinusoidal 18 g random vibration)	
UL	ANSI/UL 61010-1 acc. E325110	
EAC		

### Weight

~ 90 g

### Packaging (Please state on order)

Single packaging in cardboard accessories integrated

Multiple packaging in cardboard (25 pcs)

<sup>1)</sup> Warranty of IP protection only with suitable classified plug (consider manufacturers' instructions)

<sup>2)</sup> E1 approval for customer specific type on request

<sup>3)</sup> Pressure sensor for 12 V and 24 V power system (0 ... 5 V, 0 ... 10 V and 4 ... 20 mA)

<sup>4)</sup> types M12x1 only

## Accuracy

Parameter	Unit	
Characteristic line acc. IEC 61298-2 <sup>1),2)</sup>	% fs	± 0.5
Resolution	% fs	0.1
Thermal characteristic <sup>3)</sup>	max. % fs/10K	± 0.2
Long term stability acc. IEC 61298-2	max. % fs	± 0.3

Test conditions: 25 °C, 45% RH

			1	2	3	4	5	6	7	8	9	10	11		
<b>Order code selection table in bar</b>			550. X X X X X X X X X X X X												
<b>Pressure range <sup>4)</sup></b>	0 ... 40 bar		9	3	3	S	0								
	0 ... 60 bar		9	4	0	S	0								
	0 ... 100 bar		9	4	1	S	0								
	0 ... 160 bar		9	4	2	S	0								
	0 ... 250 bar		9	4	3	S	0								
	0 ... 400 bar		9	5	4	S	0								
	0 ... 600 bar		9	5	5	S	0								
▲ Full scale signal at these pressures															
<b>Output / power supply</b>	0 ... 5 V	7 ... 33 VDC							1						
	0 ... 10 V	12 ... 33 VDC							2						
	4 ... 20 mA	7.5 ... 33 VDC							3						
	ration. 10 ... 90%	5 VDC ±10%							7						
	Kostal SLK 2.8 coding A								7	1					
<b>Electrical connection <sup>5)</sup></b>	AMP-JPT								2						
	AMP Superseal 1.5								3						
	Deutsch DT04-3P	2w: IN=1 / OUT=3	3w: IN=A / OUT=C / GND=B						4						
	Deutsch DT04-3P		3w: IN=A / OUT=B / GND=C						G						
	Deutsch DT04-4P	3w: IN=2 / OUT=1 / Case 3	4w: IN=2 / OUT=4 / GND=1 / Case=3						Y						
	Metri Pack 150 P2S	2w: IN=B / OUT=A	3w: IN=B / OUT=C / GND=A						5						
	Metri Pack 150 P2S		3w: IN=C / OUT=A / GND=B					1,2	J						
	M12x1	2w: IN=1 / OUT=3	3w: IN=1 / OUT=4 / GND=3							S					
		2w: IN=1 / OUT=4	3w: IN=1 / OUT=3 / GND=4							M					
		2w: IN=1 / OUT=2	3w: IN=1 / OUT=2 / GND=3							P					
<b>Pressure connection <sup>4)</sup></b>	Outside thread	<sup>7</sup> / <sub>16</sub> -20 UNF									2	2	1		
		<sup>7</sup> / <sub>16</sub> -20 UNF sealed at back, SAE-4 ORB with O-ring FPM									G	2	1		
		<sup>9</sup> / <sub>16</sub> -18 UNF sealed at back, SAE-6 ORB with O-ring FPM									V	2	1		
		<sup>1</sup> / <sub>4</sub> -18 NPT									3	2	1		
		G <sup>1</sup> / <sub>4</sub> sealed at back ISO 1179-2 (DIN 3852-E) with profile seal FPM									4	2	1		
		G <sup>1</sup> / <sub>8</sub> sealed at back ISO 1179-2 (DIN 3852-E) with profile seal FPM <sup>6)</sup>									H	2	1		
M14x1.5 sealed at back ISO 9974-2 (DIN 3852-E) with profile seal FPM									6	2	1				
R <sup>1</sup> / <sub>4</sub> acc. EN 10226									7	2	1				
<b>Pressure range variation (optional)</b>	Indicate W and state range on order (e.g.: W0... + 50bar/Out1...8V)													W	

			1	2	3	4	5	6	7	8	9	10	11		
<b>Order code selection table in psi</b>			550. X X X X X X X X X X X X												
<b>Pressure range <sup>4)</sup></b>	0 ... 750 psi		9	D	0	S	0								
	0 ... 1000 psi		9	D	1	S	0								
	0 ... 2000 psi		9	D	2	S	0								
	0 ... 3000 psi		9	D	3	S	0								
	0 ... 5000 psi		9	E	4	S	0								
	0 ... 7500 psi		9	E	5	S	0								
	▲ Full scale signal at these pressures														
<b>Output / power supply</b>	0 ... 5 V	7 ... 33 VDC							1						
	0 ... 10 V	12 ... 33 VDC							2						
	4 ... 20 mA	7.5 ... 33 VDC							3						
	ration. 10 ... 90%	5 VDC ±10%							7						
	Kostal SLK 2.8 coding A								7	1					
<b>Electrical connection <sup>5)</sup></b>	AMP-JPT								2						
	AMP Superseal 1.5								3						
	Deutsch DT04-3P	2w: IN=A / OUT=B	3w: IN=A / OUT=C / GND=B						4						
	Deutsch DT04-3P		3w: IN=A / OUT=B / GND=C						G						
	Deutsch DT04-4P	3w: IN=2 / OUT=1 / Case=3	4w: IN=2 / OUT=4 / GND=1 / Case 3						Y						
	Metri Pack 150 P2S	2w: IN=B / OUT=A	3w: IN=B / OUT=C / GND=A						5						
	Metri Pack 150 P2S		3w: IN=C / OUT=A / GND=B					1,2	J						
	M12x1	2w: IN=1 / OUT=3	3w: IN=1 / OUT=4 / GND=3							S					
		2w: IN=1 / OUT=4	3w: IN=1 / OUT=3 / GND=4							M					
		2w: IN=1 / OUT=2	3w: IN=1 / OUT=2 / GND=3							P					
<b>Pressure connection <sup>4)</sup></b>	Outside thread	<sup>7</sup> / <sub>16</sub> -20 UNF									2	2	1		
		<sup>7</sup> / <sub>16</sub> -20 UNF sealed at back, SAE-4 ORB with O-ring FPM									G	2	1		
		<sup>9</sup> / <sub>16</sub> -18 UNF sealed at back, SAE-6 ORB with O-ring FPM									V	2	1		
		<sup>1</sup> / <sub>4</sub> -18 NPT									3	2	1		
		G <sup>1</sup> / <sub>4</sub> sealed at back ISO 1179-2 (DIN 3852-E) with profile seal FPM									4	2	1		
		G <sup>1</sup> / <sub>8</sub> sealed at back ISO 1179-2 (DIN 3852-E) with profile seal FPM <sup>6)</sup>									H	2	1		
M14x1.5 sealed at back ISO 9974-2 (DIN 3852-E) with profile seal FPM									6	2	1				
R <sup>1</sup> / <sub>4</sub> acc. EN 10226									7	2	1				
<b>Pressure range variation (optional)</b>	Indicate W and state range on order (e.g.: W0... + 650psi/Out1...8V)													W	

<sup>1)</sup> incl. zero point, full scale, linearity, hysteresis and repeatability  
<sup>4)</sup> Other pressure ranges and pressure connections on request

<sup>2)</sup> Considering EMC interference < ±1.5% fs  
<sup>5)</sup> Delivery without female connector

<sup>3)</sup> -40 ... +100 °C  
<sup>6)</sup> Pressure range ≤ 250 bar, 3000 psi (max. rupture pressure 1000 bar, 14500 psi)

Order code selection table in MPa		1	2	3	4	5	6	7	8	9	10	11	
		550.	X	X	X	X	X	X	X	X	X	X	
Pressure range <sup>1)</sup>	0 ... 4 MPa	9	H	3	S	0							
	0 ... 6 MPa	9	K	0	S	0							
	0 ... 10 MPa	9	K	1	S	0							
	0 ... 16 MPa	9	K	2	S	0							
	0 ... 25 MPa	9	K	3	S	0							
	0 ... 40 MPa	9	L	4	S	0							
	0 ... 60 MPa	9	L	5	S	0							
▲ Full scale signal at these pressures													
Output / power supply	0 ... 5 V      7 ... 33 VDC							1					
	0 ... 10 V      12 ... 33 VDC							2					
	4 ... 20 mA      7.5 ... 33 VDC							3					
	ratiom. 10 ... 90%      5 VDC ±10%							7					
Electrical connection <sup>2)</sup>	Kostal SLK 2.8 coding A							7	1				
	AMP-JPT								2				
	AMP Superseal 1.5								3				
	Deutsch DT04-3P      2w: IN=A / OUT=B      3w: IN=A / OUT=C / GND=B								4				
	Deutsch DT04-3P      3w: IN=A / OUT=B / GND=C								G				
	Deutsch DT04-4P      3w: IN=2 / OUT=1 / Case=3      4w: IN=2 / OUT=4 / GND=1 / Case 3								Y				
	Metri Pack 150 P2S      2w: IN=B / OUT=A      3w: IN=B / OUT=C / GND=A								5				
	Metri Pack 150 P2S      3w: IN=C / OUT=A / GND=B							1,2	J				
	M12x1	2w: IN=1 / OUT=3      3w: IN=1 / OUT=4 / GND=3								S			
		2w: IN=1 / OUT=4      3w: IN=1 / OUT=3 / GND=4								M			
2w: IN=1 / OUT=2      3w: IN=1 / OUT=2 / GND=3									P				
Pressure connection <sup>1)</sup>	Outside thread									2	2	1	
	7/16-20 UNF									G	2	1	
	7/16-20 UNF sealed at back, SAE-4 ORB with O-ring FPM									V	2	1	
	9/16-18 UNF sealed at back, SAE-6 ORB with O-ring FPM									3	2	1	
	1/4 -18 NPT									4	2	1	
	G 1/4 sealed at back ISO 1179-2 (DIN 3852-E) with profile seal FPM									H	2	1	
	G 1/8 sealed at back ISO 1179-2 (DIN 3852-E) with profile seal FPM <sup>3)</sup>									6	2	1	
M14x1.5 sealed at back ISO 9974-2 (DIN 3852-E) with profile seal FPM									7	2	1		
R 1/4 acc. EN 10226													
Pressure range variation (optional)	Indicate W and state range on order (e.g.: W0... + 5MPa/Out1...8V)											W	

Accessories (supplied loose)		Order Number
Set - Female connector Kostal SLK 2.8 coding A	2 wire (3 wire with 1 blanking plug)	120369
Set - Female connector Kostal SLK 2.8 coding A	3 wire	120368
Set - Female connector AMP JPT	2 wire (3 wire with 1 blanking plug)	110442
Set - Female connector AMP JPT	3 wire	108767
Set - Female connector AMP Superseal 1.5 (0.5 - 1.0 mm <sup>2</sup> )	3 wire (Blanking Plug to enable 2 wire)	120254
Set - Female connector AMP Superseal 1.5 (1.0 - 1.5 mm <sup>2</sup> )	3 wire (Blanking Plug to enable 2 wire)	120255
Set - Female connector Metri Pack 150 P2S Series	3 wire	120345
Calibration certificate		104551

<sup>1)</sup> Other pressure ranges and pressure connections on request

<sup>2)</sup> Delivery without female connector

<sup>3)</sup> Pressure range ≤ 25 MPa (max. rupture pressure 100 MPa)

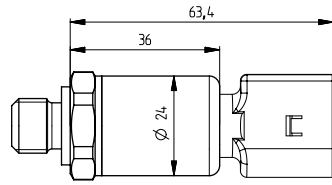
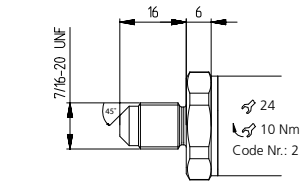

Kostal SLK 2.8

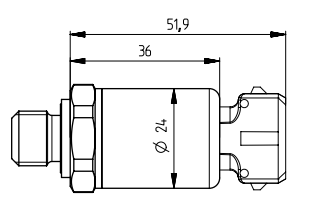
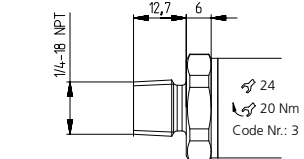
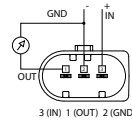

AMP JPT

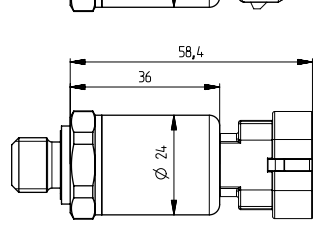
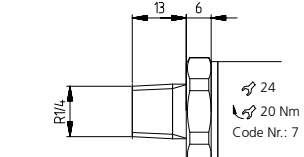
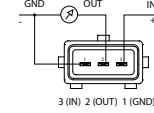
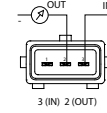

AMP Superseal 1.5

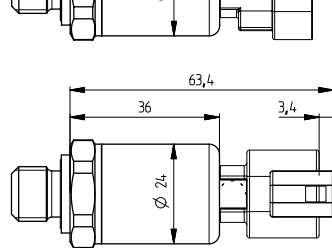
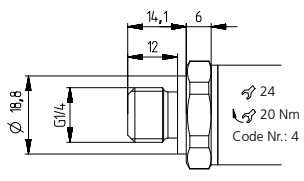
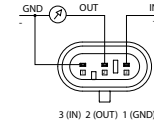
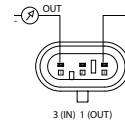

Deutsch DT04-3P

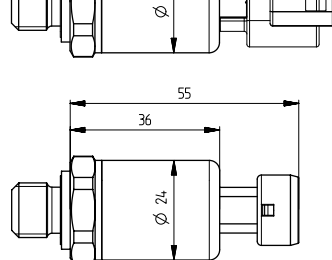
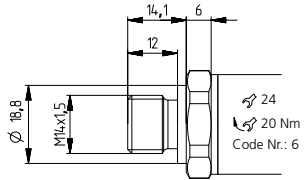
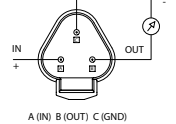
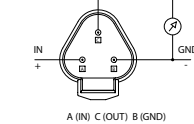
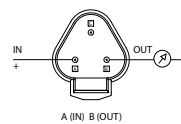

Metri Pack Series 150 P2S

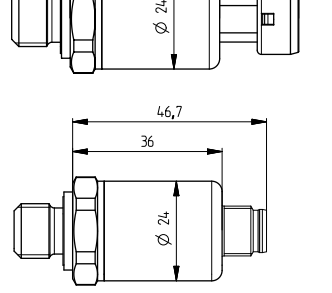
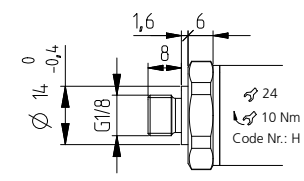
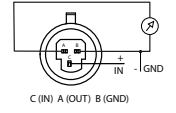
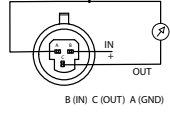
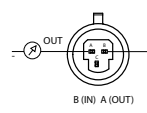

M12x1

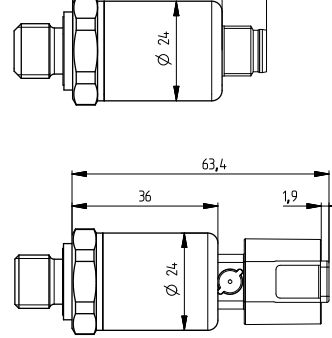
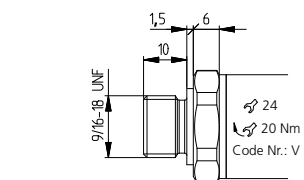
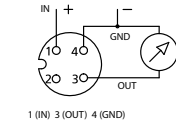
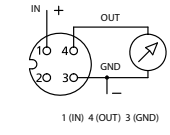
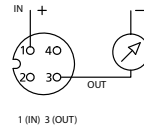

Deutsch DT04-4P

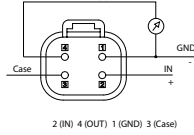
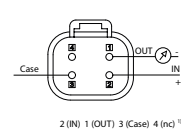
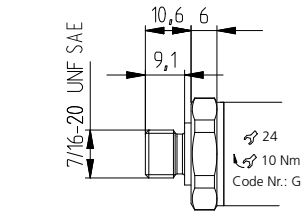
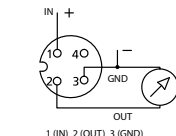
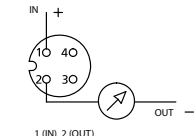
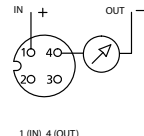

<sup>1)</sup> not connected

**Huba Control AG**

Industriestrasse 17  
5436 Würenlos, Switzerland  
Tel. +41 56 436 82 00  
[info.ch@hubacontrol.com](mailto:info.ch@hubacontrol.com)



Consultancy in your area  
[hubacontrol.com/en/worldwide](https://hubacontrol.com/en/worldwide)

