



Pressure switch

## Relative and absolute pressure switch Type 529

The compact type 529 pressure switch is based upon the Huba Control developed unique ceramic technology used for the last 20 years in millions of applications.

Switching points set in factory are available both N/C and N/O function. Various electrical and pressure connections are available to suit given applications.

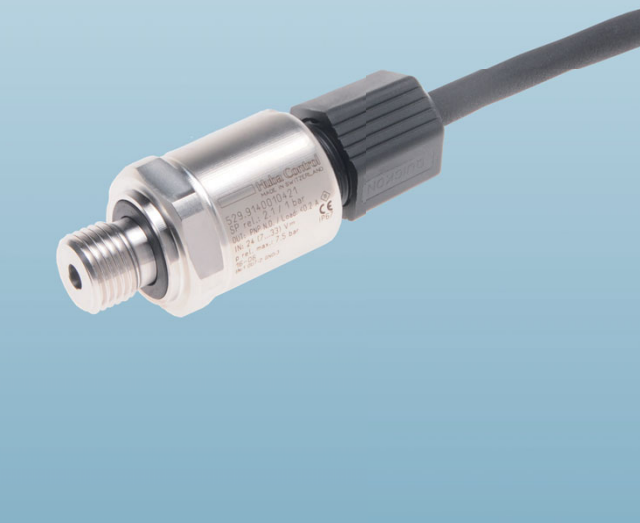

**Pressure range**  
**-1 ... 0 – 60 bar**

- + Compact, rugged construction
- + Negligible temperature influence on accuracy
- + Large selection of connections available.
- + Saving time by quick cable mounting by the customer with swift connector

## Technical overview

### Pressure range

Relative	-1 ... 0 – 60 bar
Absolute	0 ... 1 – 16 bar

### Operating conditions

Medium		Liquids and gases
		FPM -15 ... +125 °C
		EPDM -40 ... +125 °C
Temperature	Medium	NBR -20 ... +100 °C
		MVQ -40 ... +125 °C
	Ambient	-30 ... +85 °C
	Storage	-50 ... +100 °C
Tolerable overload / Rupture pressure	≤ 4 bar	3.0 x fs
	> 4 bar	2.5 x fs

### Materials

Pressure Connection		Stainless steel 1.4404 / AISI 316L
Plug accommodation		Polyarylamide 50% GF UL 94 V-0
Materials in contact with medium	Pressure connection	Stainless steel 1.4404 / AISI 316L
	Sensor	Ceramic Al <sub>2</sub> O <sub>3</sub> (96%)
	Sealing material	FPM, EPDM, NBR, MVQ

### Electrical overview

Output		Semiconductor (open collector)
Switching contact	High-Side Switch (PNP)	N/C contact or N/O contact
Switch load	High-Side Switch (PNP)	max. 200 mA
Power supply		7 ... 33 VDC
Current consumption		< 4 mA
Insulation voltage		500 VDC

### Dynamic response

Response time	< 2 ms, 1 ms typ.
Load cycle	< 100 Hz

### Adjustment of switching points (factory set)

Upper switching point	8 ... 100% fs
Lower switching point	5 ... 97% fs
Hysteresis	≥ 3 % fs

### Electrical connection

	Protection standard	Protection class
Swift connector with or without cable 1.5 m	IP 67	III
Connector M12x1	IP 67	III

### Pressure connection

Inside thread	G ¼	with O-Ring seal FPM (-30 ... +135 °C)
	½ -14 NPT	
	7/16 - 20 UNF	
Outside thread	7/16 - 20 UNF	sealing cone 45°
	¼ -18 NPT	
	G ¼	sealed at back DIN EN ISO 1179-2 with Profile seal ring in FPM (-30 ... +135 °C)
	R ¼	EN 10226
	G ½	sealed at back and manometer (combi) with Profile seal ring in FPM (-30 ... +135 °C)
	M20x1.5	sealed at front and manometer (combi)
	G ½	sealed at front

### Installation arrangement

Unrestricted	<b>Recommendation:</b> Pressure connection facing downwards
--------------	---

### Tests / Admissions

Electromagnetic compatibility	CE conformity acc. EN 61326-2-3 and 50121-3-2
Shock acc. IEC 68-2-27	100 g, 11 ms half sine wave, all 6 directions, free fall from 1 m on concrete (6x)
Constant shock acc. IEC 68-2-29	40 g for 6 ms, 1000x all 3 directions
Vibration acc. IEC 68-2-6	20 g, 15 ... 2000 Hz, 15 ... 25 Hz with amplitude ± 15 mm, 1 Octave/min. all 3 directions, 50 constant load
UL	ANSI/UL 61010-1 acc. E325110
EAC	

### Weight

~ 90 g
--------

### Packaging (Please state on order)

Single packaging in cardboard	accessories integrated
Multiple packaging in cardboard (25 pcs)	

## Accuracy

Parameter		Unit	
Switching points <sup>1)</sup>		% fs	± 0.5
Resolution		% fs	0.1
Thermal characteristic <sup>2)</sup>	max.	% fs/10K	± 0.2
Long term stability acc. IEC EN 60770-1	max.	% fs	± 0.25

Test conditions: 25°C, 45% RH, power supply 24 VDC

<sup>1)</sup> typ. ; max. 1.0% fs (incl. hysteresis and repeatability)

<sup>2)</sup> -15 ... 85 °C

		1	2	3	4	5	6	7	8	9	10	11	
<b>Order code selection table in bar</b>		529. X X X X X X X X X X X X											
<b>Pressure range (relative)</b> <sup>1)</sup>	-1 ... 0 bar	9	0	1									
	0 ... 1 bar	9	1	1									
	0 ... 1.6 bar	9	1	2									
	0 ... 2.5 bar	9	1	4		0							
	0 ... 4 bar	9	1	5		0							
	0 ... 6 bar	9	1	7		0							
	0 ... 10 bar	9	3	0		0							
	0 ... 16 bar	9	3	1		0							
	0 ... 25 bar	9	3	2		0							
	0 ... 40 bar	9	3	3		0							
0 ... 60 bar	9	4	0		0								
<b>Pressure range (absolute)</b> <sup>1)</sup>	0 ... 1 bar	8	1	1									
	0 ... 1.6 bar	8	1	2									
	0 ... 2.5 bar	8	1	4									
	0 ... 4 bar	8	1	5									
	0 ... 6 bar	8	1	7									
	0 ... 10 bar	8	3	0									
	0 ... 16 bar	8	3	1									
<b>Sealing material</b>	FPM Fluoro elastomer					0							
	EPDM Ethylene propylene					1							
	NBR Butadiene Acrylonitrile					2							
	MVQ Silicone polymer					3							
<b>Application</b>	standard					0							
	for oxygen applications					0	1				1		
<b>Switching contact</b>	Contact N/O High-Side-Switch PNP							1					
	Contact N/C High-Side-Switch PNP							2					
<b>Electrical connection</b>	Swift connector without cable								0				
	Connector M12x1 <sup>2)</sup>								3				
	Swift connector with cable 1.5 m								L				
<b>Pressure connection</b> <sup>3)</sup>	Inside thread	G ¼ with O-Ring seal FPM									1		
		½ -14 NPT									D		
		7/16 -20 UNF									K		
	Outside thread	7/16 -20 UNF										2	
		¼ -18 NPT										3	
		G ¼ sealed at back DIN EN ISO 1179-2 with Profile seal ring in FPM										4	
		R ¼ acc. to EN 10226										7	
		G ½ sealed at back and manometer with Profile seal ring in FPM										8	
		M20x1.5 sealed at front and manometer (combi)										E	
G ½ sealed at front										9			
<b>Pressure orifice</b>	without										1	1	
	with										2	1	
<b>Switching points</b>	Indicate W and state switching points on order (e.g.: W40/30bar)											W	

Accessories (supplied loose)	Order number
Swift connector	117312
Corner-wire box for connector M12x1 with cable 2.0 m	114604
Straight-wire box for connector M12x1	114570
Straight-wire box for connector M12x1 with cable 2.0 m	114605
Mounting bracket with screw	118716
Heat sink with outside thread G ½ sealed at front - inside thread G ½	105631
Heat sink with outside thread G ½ sealed at front - inside thread G ¼	105073
Heat sink with outside thread G ¼ sealed at front - inside thread G ¼	105074
Calibration certificate (at factory set switching points)	104551

Mounting bracket

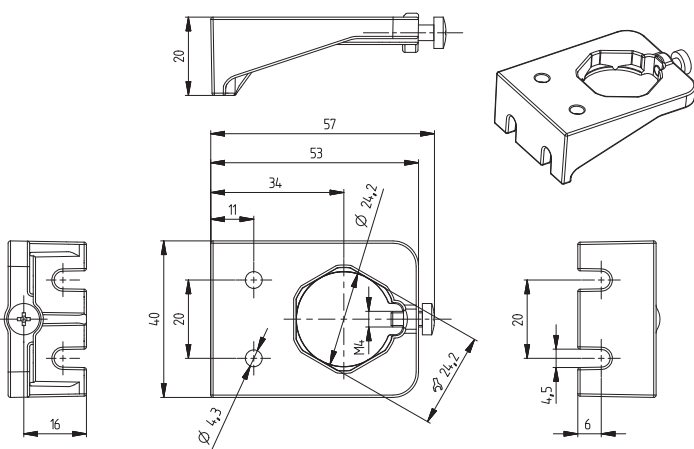

Heat sink

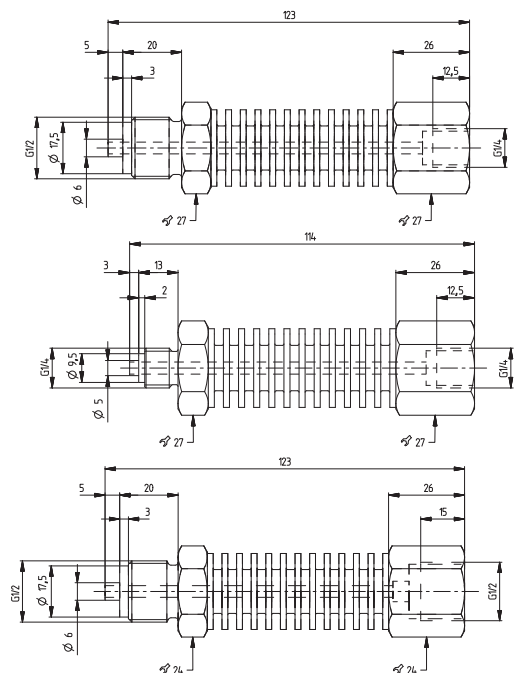

<sup>1)</sup> Other pressure ranges on request

<sup>2)</sup> Delivery without female connector

<sup>3)</sup> Other pressure connections on request

			1	2	3	4	5	6	7	8	9	10	11	
<b>Order code selection table in psi</b>			529.	X	X	X	X	X	X	X	X	X	X	
<b>Pressure range (relative) <sup>1)</sup></b>	-30 ... 0"hg		9	B	0									
	0 ... 15 psi		9	B	1									
	0 ... 20 psi		9	B	2									
	0 ... 30 psi		9	B	4			0						
	0 ... 60 psi		9	B	5			0						
	0 ... 100 psi		9	B	7			0						
	0 ... 150 psi		9	C	0			0						
	0 ... 200 psi		9	C	1			0						
	0 ... 300 psi		9	C	2			0						
	0 ... 500 psi		9	C	3			0						
0 ... 750 psi		9	D	0			0							
<b>Pressure range (absolute) <sup>1)</sup></b>	0 ... 15 psi		8	B	1									
	0 ... 20 psi		8	B	2									
	0 ... 30 psi		8	B	4									
	0 ... 60 psi		8	B	5									
	0 ... 100 psi		8	B	7									
	0 ... 150 psi		8	C	0									
0 ... 200 psi		8	C	1										
<b>Sealing material</b>	FPM	Fluoro elastomer					0							
	EPDM	Ethylene propylene					1							
	NBR	Butadiene Acrylonitrile					2							
	MVQ	Silicone polymer					3							
<b>Application</b>	standard						0							
	for oxygen applications						0	1			1			
<b>Switching contact</b>	Contact N/O	High-Side-Switch PNP							1					
	Contact N/C	High-Side-Switch PNP							2					
<b>Electrical connection</b>	Swift connector without cable									0				
	Connector M12x1 <sup>2)</sup>									3				
	Swift connector with cable 1.5 m									L				
<b>Pressure connection <sup>3)</sup></b>	Inside thread	G 1/4 with O-Ring seal FPM										1		
		1/2 -14 NPT											D	
		7/16 -20 UNF											K	
		7/16 -20 UNF											2	
		1/4 -18 NPT											3	
	Outside thread	G 1/4 sealed at back DIN EN ISO 1179-2 with Profile seal ring in FPM											4	
		R 1/4 acc. to EN 10226											7	
		G 1/2 sealed at back and manometer with Profile seal ring in FPM											8	
		M20x1.5 sealed at front and manometer (combi)											E	
		G 1/2 sealed at front											9	
<b>Pressure orifice</b>	without											1	1	
	with											2	1	
<b>Switching points</b>	Indicate W and state switching points on order (e.g.: W30/16psi)												W	

## Dimensions in mm / Electrical connections

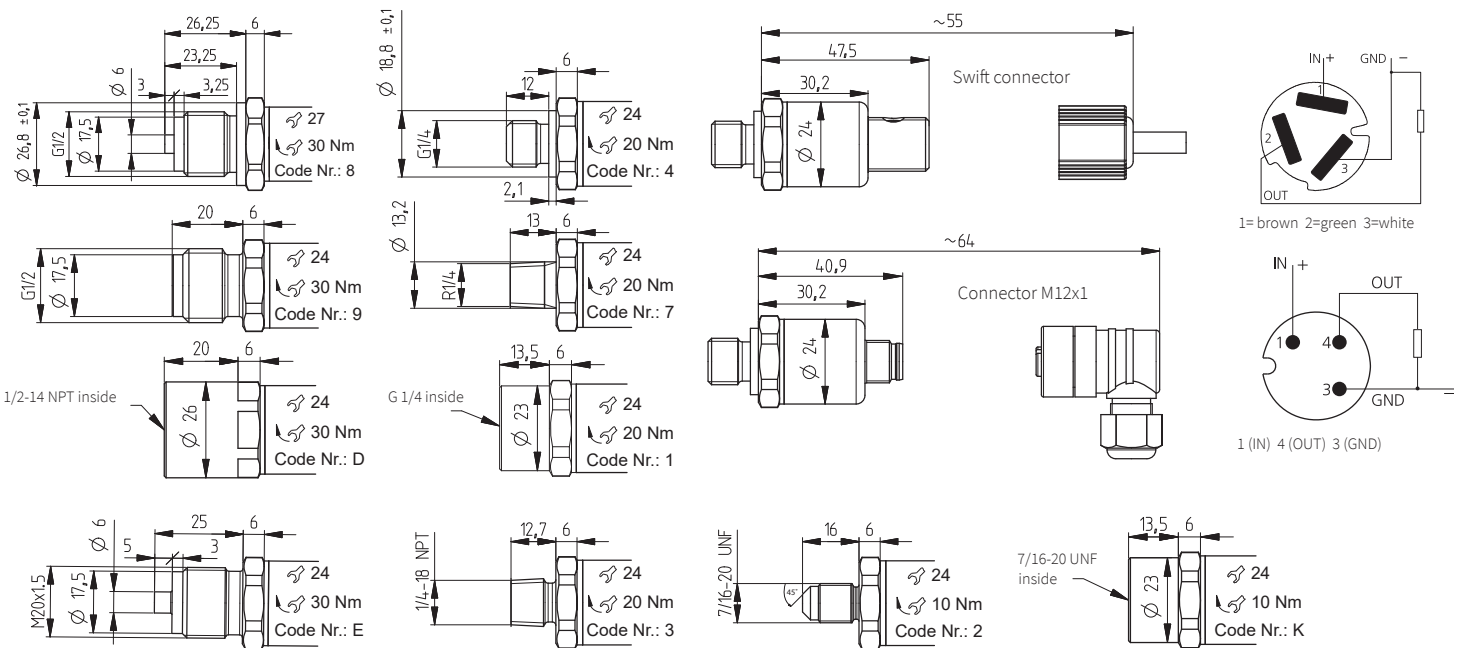

<sup>1)</sup> Other pressure ranges on request      <sup>2)</sup> Delivery without female connector      <sup>3)</sup> Other pressure connections on request

			1	2	3	4	5	6	7	8	9	10	11	
<b>Order code selection table in MPa</b>			529.	X	X	X	X	X	X	X	X	X	X	
<b>Pressure range (relative) <sup>1)</sup></b>	-0.1 ... 0 MPa		9	G	0									
	0 ... 0.1 MPa		9	G	1									
	0 ... 0.16 MPa		9	G	2									
	0 ... 0.25 MPa		9	G	4		0							
	0 ... 0.4 MPa		9	G	5		0							
	0 ... 0.6 MPa		9	G	7		0							
	0 ... 1 MPa		9	H	0		0							
	0 ... 1.6 MPa		9	H	1		0							
	0 ... 2.5 MPa		9	H	2		0							
	0 ... 4 MPa		9	H	3		0							
0 ... 6 MPa		9	K	0		0								
<b>Pressure range (absolute) <sup>1)</sup></b>	0 ... 0.1 MPa		8	G	1									
	0 ... 0.16 MPa		8	G	2									
	0 ... 0.25 MPa		8	G	4									
	0 ... 0.4 MPa		8	G	5									
	0 ... 0.6 MPa		8	G	7									
	0 ... 1 MPa		8	H	0									
	0 ... 1.6 MPa		8	H	1									
<b>Sealing material</b>	FPM	Fluoro elastomer					0							
	EPDM	Ethylene propylene					1							
	NBR	Butadiene Acrylonitrile					2							
	MVQ	Silicone polymer					3							
<b>Application</b>	standard						0							
	for oxygen applications						0	1				1		
<b>Switching contact</b>	Contact N/O	High-Side-Switch PNP							1					
	Contact N/C	High-Side-Switch PNP							2					
<b>Electrical connection</b>	Swift connector without cable									0				
	Connector M12x1 <sup>2)</sup>									3				
	Swift connector with cable 1.5 m									L				
<b>Pressure connection <sup>3)</sup></b>	Inside thread	G ¼ with O-Ring seal FPM									1			
		½ -14 NPT									D			
		7/16 -20 UNF										K		
	Outside thread	7/16 -20 UNF										2		
		¼ -18 NPT											3	
		G ¼ sealed at back DIN EN ISO 1179-2 with Profile seal ring in FPM											4	
		R ¼ acc. to EN 10226											7	
		G ½ sealed at back and manometer with Profile seal ring in FPM											8	
		M20x1.5 sealed at front and manometer (combi)											E	
G ½ sealed at front											9			
<b>Pressure orifice</b>	without										1	1		
with										2	1			
<b>Switching points</b>	Indicate W and state switching points on order (e.g.: W4/1.2MPa)												W	

## Function

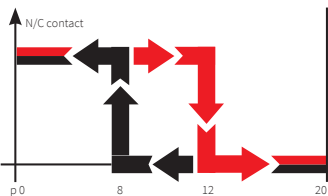

**N/C contact:** When pressure is applied ( $p_0 \rightarrow p_{max}$ ) the switch will disconnect the applied load as soon as the upper switching point is reached. As the pressure falls ( $p_{max} \rightarrow p_0$ ) the switch will connect the load as soon as the lower switching point is reached.

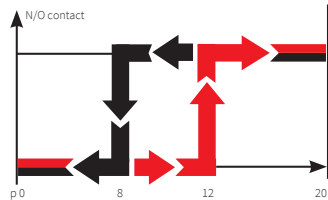

**N/O contact:** When pressure is applied ( $p_0 \rightarrow p_{max}$ ) the switch will connect the applied load as soon as the upper switching point is reached. With a fall in pressure ( $p_{max} \rightarrow p_0$ ) the switch will disconnect the load as soon as the lower switching point is reached.

Example:  $p_0$  20 bar  
 Upper switching point 12 bar  
 Lower switching point 8 bar  
 max. switching load 100 mA

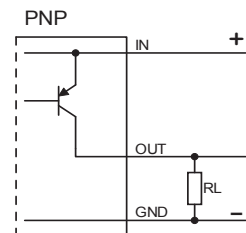

<sup>1)</sup> Other pressure ranges on request      <sup>2)</sup> Delivery without female connector      <sup>3)</sup> Other pressure connections on request

**Huba Control AG**

Headquarters Schweiz  
Industriestrasse 17  
CH-5436 Würenlos  
Telefon +41 56 436 82 00  
Fax +41 56 436 82 82  
info.ch@hubacontrol.com

**Huba Control AG**

Niederlassung Deutschland  
Schlattgrabenstrasse 24  
D-72141 Walddorfhäslach  
Telefon +49 7127 2393 00  
Fax +49 7127 2393 20  
info.de@hubacontrol.com

**Huba Control AG**

Vestiging Nederland  
Hamseweg 20A  
NL-3828 AD-Hoogland  
Telefoon +31 33 433 03 66  
Telefax +31 33 433 03 77  
info.nl@hubacontrol.com

**Huba Control SA**

Succursale France  
Rue Lavoisier  
Technopôle Forbach-Sud  
F-57602 Forbach Cedex  
Téléphone +33 3 87 84 73 00  
Télécopieur +33 3 87 84 73 01  
info.fr@hubacontrol.com

**Huba Control AG**

Branch Office United Kingdom  
Unit 13 Berkshire House, County Park  
Business Centre, Shivenham Road  
Swindon - Wiltshire SN1 2NR  
Phone +44 1993 77 66 67  
Fax +44 1993 77 66 71  
info.uk@hubacontrol.com

**[www.hubacontrol.com](http://www.hubacontrol.com)**

