

Relative and absolute pressure transmitter type 528

Pressure range
-1 ... 0 – 60 bar



The compact type 528 pressure transmitter is based upon the well proven ceramic technology developed by Huba Control over 20 years ago.

These transmitters are suitable for applications across a broad spectrum of industries.

- Compact, rugged construction
- Negligible temperature influence on accuracy
- Large selection of connections available
- Saving time by quick cable mounting by the customer with swift connector

Technical overview

Pressure range

Relative	-1 ... 0 – 60 bar
Absolute	0 ... 1 – 16 bar

Operating conditions

Medium		Liquids and gases
Temperature	Medium	FPM -15 ... +125 °C (⊕ -15 ... +120 °C)
		EPDM -40 ... +125 °C (⊕ -30 ... +120 °C)
		NBR -20 ... +100 °C
	Ambient	MVQ -40 ... +125 °C (⊕ -30 ... +120 °C)
		FPM -40 ... +125 °C (⊕ -30 ... +120 °C)
		-30 ... +85 °C (⊕ -25 ... +85 °C)
Storage	-50 ... +100 °C	
Tolerable overload / Rupture pressure	≤ 4 bar	3.0 x fs
	> 4 bar	2.5 x fs

Materials

Cover	Stainless steel 1.4404 / AISI 316L	
Plug accommodation	Polyarylamide 50% GF UL 94 V-0	
Materials in contact with medium	Pressure connection	Stainless steel 1.4404 / AISI 316L
	Sensor	PVDF
		Ceramic Al ₂ O ₃ (96%)
	Sealing material	FPM, EPDM, NBR, MVQ

Electrical overview

	Output	Power supply	Load	Current consumption
2 wire	4 ... 20 mA	7 ... 33 VDC	< $\frac{\text{supply voltage} - 7 \text{ V}}{0.02 \text{ A}}$ [Ohm]	< 23 mA
	⊕ 4 ... 20 mA	10 ... 30 VDC	< $\frac{\text{supply voltage} - 10 \text{ V}}{0.02 \text{ A}}$ [Ohm]	< 23 mA
	0 ... 5 V	7 ... 33 VDC	>10 kOhm / < 100 nF	< 7 mA
	1 ... 6 V	8 ... 33 VDC	>10 kOhm / < 100 nF	< 7 mA
3 wire	0 ... 10 V	12 ... 33 VDC	>10 kOhm / < 100 nF	< 7 mA
	0 ... 10 V	12 ... 33 VDC / 24 VAC ± 15%	>10 kOhm / < 100 nF	< 7 mA
	⊕ ratiom. 10 ... 90%	5 VDC ± 10%	>10 kOhm / < 100 nF	< 7 mA
	⊕ ratiom. 10 ... 90%	5 VDC ± 10%	>10 kOhm / < 100 nF	< 7 mA
Polarity reversal protection	Short circuit proof and protected against polarity reversal. Each connection is protected against crossover up to max. supply voltage.			
Insulation voltage	500 VDC			

Dynamic response

Response time	< 2 ms, 1 ms typ.
Load cycle	< 100 Hz

Electrical connection

	Protection standard	Protection class
Swift connector with or without cable 1.5 / 2.0 / 3.0 / 5.0 m (PVC spec.)	IP 67	III
Connector DIN EN 175301-803-A or C (industrial standard 9.4 mm)	IP 65	III
Metri Pack Serie 150	IP 67	III
Connector M12x1	IP 67	III
Braids	IP 65	III
Connector RAST 2.5 (3 wire, only)	IP 00	III

Pressure connection

Inside thread	7/16 - 20 UNF	
	1/2 - 14 NPT	
	G 1/4	with O-Ring seal FPM (-30 ... +135 °C)
Outside thread	7/16 - 20 UNF	sealing cone
	1/4 - 18 NPT	
	7/16 - 20 UNF	sealed at back SAE 4 with O-Ring seal FPM (-20 ... +135 °C)
	G 1/4, G 1/2, G 3/8	sealed at back DIN 3852-E with Profile seal ring in FPM (-30 ... +135 °C)
	G 1/4, G 1/2	sealed at back and manometer (combi) with Profile seal ring in FPM (-30 ... +135 °C)
	R 1/4	EN 10226
	3/8 - 27 NPT	
	G 1/8	sealed at front or sealed at back and manometer (combi) with Profile seal ring in FPM (-30 ... +135 °C)
	M10x1	sealed at back DIN 3852-E with Profile seal ring in FPM (-30 ... +135 °C)
	M20x1.5	sealed at front and manometer (combi)
G 1/4, G 1/2	sealed at front	

Installation arrangement

Unrestricted	Recommendation: Pressure connection facing downwards
--------------	---

Tests / Admissions

Electromagnetic compatibility	CE conformity acc. EN 61326-2-3
Enhanced EMC protection	EN 50121-3-2
Shock acc. IEC 68-2-27	100 g, 11 ms half sine wave, all 6 directions, free fall from 1 m on concrete (6x)
Constant shock acc. IEC 68-2-29	40 g for 6 ms, 1000x all 3 directions
Vibration acc. IEC 68-2-6	20 g, 15 ... 2000 Hz, 15 ... 25 Hz with amplitude ± 15 mm, 1 Octave/min. all 3 directions, 50 constant load
UL	ANSI/UL 61010-1 acc. E325110
Drinking water approval	NSF/ANSI 61/372 acc. MH60087
EAC	

Protection against explosion (⊕)

	ratiom. 10 ... 90%	4 ... 20 mA
Intrinsic safety «i»	Ex II 1/2 G Ex ia IIC T4 Ga/Gb	Ex II 1/2 G Ex ia IIC T4 Ga/Gb
EC type examination certificate	Ex II 1/2 D Ex ia IIC T125°C Da/Db	Ex II 1/2 D Ex ia IIC T125°C Da/Db
Connection to certified intrinsically safe resistive circuits with maximum values	SEV 15 ATEX 0173	SEV 10 ATEX 0145
Effective internal inductance and capacitance for versions with plugs complying with EN 175301-803-A or M12x1	Ui ≤ 15 VDC; li ≤ 200 mA; Pi ≤ 750 mW	Ui ≤ 30 VDC; li ≤ 100 mA; Pi ≤ 750 mW
IECEX	Li = 0 nH; Ci ≤ 150 nF	Li = 0 nH; Ci = 0 nF
		SEV 16.0007

Weight

~ 90 g

Packaging (Please state on order)

Single packaging in cardboard	accessories integrated
Multiple packaging in cardboard (25 pcs)	

Accuracy

Parameter	Unit	
Characteristic line ¹⁾	% fs	± 0.3
Resolution	% fs	0.1
Thermal characteristic ²⁾	max. % fs/10K	± 0.2
Long term stability acc. IEC EN 60770-1	max. % fs	± 0.25

Test conditions: 25 °C, 45% RH, power supply 24 VDC

Order code selection in bar			1	2	3	4	5	6	7	8	9	10	11			
			528.	X	X	X	X	X	X	X	X	X	X			
Pressure range (relative) ³⁾	-1 ... 0 bar		9	0	1											
	0 ... 1 bar		9	1	1											
	0 ... 1.6 bar		9	1	2											
	0 ... 2.5 bar		9	1	4		0,4									
	0 ... 4 bar		9	1	5		0,4									
	0 ... 6 bar		9	1	7		0,4									
	0 ... 10 bar		9	3	0		0,4									
	0 ... 16 bar		9	3	1		0,4									
	0 ... 25 bar		9	3	2		0,4					1				
	0 ... 40 bar		9	3	3		0,4					1				
0 ... 60 bar		9	4	0		0,4					1					
Pressure range (absolute) ³⁾	0 ... 1 bar		8	1	1											
	0 ... 1.6 bar		8	1	2											
	0 ... 2.5 bar		8	1	4											
	0 ... 4 bar		8	1	5											
	0 ... 6 bar		8	1	7											
	0 ... 10 bar		8	3	0											
0 ... 16 bar		8	3	1												
Sealing material	FPM	Fluoro elastomer (Ⓢ -15 ... +120 °C)					0									
	EPDM	Ethylene propylene (Ⓢ -30 ... +120 °C)					1									
	NBR	Butadiene Acrylonitrile					2									
	MVQ	Silicone polymer (Ⓢ -30 ... +120 °C)					3									
	FPM	Fluoro elastomer (Ⓢ -30 ... +120 °C)					5									
Application	standard						0									
	for oxygen applications						0	1			1	1				
	with drinking water approval NSF 61						0	4			1	1				
Output / power supply	0 ... 5 V	7 ... 33 VDC							1							
	1 ... 6 V	8 ... 33 VDC							6							
	0 ... 10 V	12 ... 33 VDC							2							
		12 ... 33 VDC Enhanced EMC protection							C	1,2,3						
		12 ... 33 VDC / 24 VAC ±15% (not possible with M12x1, metri Pack, RAST, braids)							8							
	ratiom. 10 ... 90%	5VDC ±10%							7							
		5VDC ±10% Ex protection					0,4		9	1,3		1				
	4 ... 20 mA	7 ... 33 VDC							3							
		7 ... 33 VDC Enhanced EMC protection (not possible with Braids)							A							
		10 ... 30 VDC Ex protection					0,4		4	1,3		1				
Electrical connection	Connector ⁴⁾	DIN EN 175301-803-A							1							
		DIN EN 175301-803-C (industrial standard 9.4 mm)							2							
		M12x1 2w: IN=1 / OUT=3 3w: IN=1 / OUT=4 / GND=3								3						
		M12x1 2w: IN=1 / OUT=4 3w: IN=1 / OUT=3 / GND=4								M						
		M12x1 2w: IN=1 / OUT=2 3w: IN=1 / OUT=2 / GND=3								P						
		RAST 2.5					0,4	7	4							
	Braids	Metri Pack Serie 150					0,4		5							
		80 ±10 mm							6							
		290 ±10 mm							7							
		480 ±10 mm							8							
		730 ±10 mm							9							
		without cable							0							
		with cable 1.5 m							L							
Swift connector	with cable 2.0 m							N								
	with cable 3.0 m							Q								
	with cable 5.0 m							R								
	Inside thread	1/16-20 UNF sealing cone										K	1			
		1/2-14 NPT										D	1			
		G 1/4 with O-Ring seal FPM										1	1			
1/16-20 UNF sealing cone		1/4-18 NPT										2	1			
		G 1/4 sealed at back DIN 3852-E with profile seal ring in FPM										3	1			
G 1/4 sealed at back and manometer with profile seal ring in FPM											4	1				
R 1/4 acc. to EN 10226											5	1				
G 1/2 sealed at back and manometer with profile seal ring in FPM							0,1				7	1				
G 1/2 sealed at back and manometer with profile seal ring in FPM											8	1				
Outside thread		1/16-20 UNF sealed at back SAE 4 with O-Ring seal FPM										G	1			
	1/8-27 NPT										A	1				
	G 1/8 sealed at front										M	1				
	G 1/8 sealed at back DIN 3852-E with Profile seal ring in FPM						0,1				H	1				
	G 1/4 sealed at front										J					
	G 1/2 sealed at back DIN 3852-E with profile seal ring in FPM						0,1				C	1				
	M10x1 sealed at back DIN 3852-E with profile seal ring in FPM						0,1				F	1				
	M20x1.5 sealed at front and manometer (combi)										E	1				
	G 1/2 sealed at front										9					
	Pressure orifice	without											1			
with												2				
Material	Stainless steel 1.4404 / AISI 316L															
pressure connection	PVDF outside thread ⁵⁾	sealed at front G 1/4, G 1/2											≤ 16 bar	J,9	1	2
Pressure range variation (optional)	Indicate W and state range on order (e.g.: W0... + 3bar/OUT0...5V)												W			

¹⁾ typ. ; max. 0.5% fs (incl. zero point, full scale, linearity, hysteresis and repeatability)

²⁾ -15 ... 85 °C

³⁾ Other pressure ranges or pressure connections on request

⁴⁾ Delivery without female connector

⁵⁾ Medium temperature -15 ... +85 °C

Order code selection in psi			1	2	3	4	5	6	7	8	9	10	11
			528.	X	X	X	X	X	X	X	X	X	X
Pressure range (relative) ¹⁾	-30 ... 0" hg		9	B	0								
	0 ... 15 psi		9	B	1								
	0 ... 20 psi		9	B	2								
	0 ... 30 psi		9	B	4			0,4					
	0 ... 60 psi		9	B	5			0,4					
	0 ... 100 psi		9	B	7			0,4					
	0 ... 150 psi		9	C	0			0,4					
	0 ... 200 psi		9	C	1			0,4					
	0 ... 300 psi		9	C	2			0,4					1
	0 ... 500 psi		9	C	3			0,4					1
0 ... 750 psi		9	D	0			0,4					1	
Pressure range (absolute) ¹⁾	0 ... 15 psi		8	B	1								
	0 ... 20 psi		8	B	2								
	0 ... 30 psi		8	B	4								
	0 ... 60 psi		8	B	5								
	0 ... 100 psi		8	B	7								
	0 ... 150 psi		8	C	0								
	0 ... 200 psi		8	C	1								
Sealing material	FPM	Fluoro elastomer (⊗ -15 ... +120 °C)						0					
	EPDM	Ethylene propylene (⊗ -30 ... +120 °C)						1					
	NBR	Butadiene Acrylonitrile						2					
	MVQ	Silicone polymer (⊗ -30 ... +120 °C)						3					
	FPM	Fluoro elastomer (⊗ -30 ... +120 °C)						5					
Application	standard							0					
	for oxygen applications							0	1			1	1
	with drinking water approval NSF 61							0	4			1	1
Output / power supply	0 ... 5 V	7 ... 33 VDC								1			
	1 ... 6 V	8 ... 33 VDC								6			
		12 ... 33 VDC								2			
	0 ... 10 V	12 ... 33 VDC Enhanced EMC protection								C	1,2,3		
		12 ... 33 VDC / 24 VAC ±15% (not possible with M12x1, metri Pack, RAST, braids)								8			
	ration. 10 ... 90%	5VDC ±10%								7			
		5VDC ±10% Ex protection						0,4		9	1,3		1
		7 ... 33 VDC								3			
	4 ... 20 mA	7 ... 33 VDC Enhanced EMC protection (not possible with Braids)								A			
		10 ... 30 VDC Ex protection						0,4		4	1,3		1
Electrical connection	Connector ²⁾	DIN EN 175301-803-A										1	
		DIN EN 175301-803-C (industrial standard 9.4 mm)										2	
		M12x1 2w: IN=1 / OUT=3 3w: IN=1 / OUT=4 / GND=3										3	
		M12x1 2w: IN=1 / OUT=4 3w: IN=1 / OUT=3 / GND=4										M	
		M12x1 2w: IN=1 / OUT=2 3w: IN=1 / OUT=2 / GND=3										P	
		RAST 2.5						0,4		7		4	
	Braids	Metri Pack Serie 150						0,4				5	
		80 ±10 mm										6	
		290 ±10 mm										7	
		480 ±10 mm										8	
		730 ±10 mm										9	
	Swift connector	without cable										0	
		with cable 1.5 m										L	
		with cable 2.0 m										N	
		with cable 3.0 m										Q	
with cable 5.0 m											R		
Pressure connection ³⁾	Inside thread	7/16-20 UNF sealing cone										K	1
		1/2 -14 NPT										D	1
		G 1/4 with O-Ring seal FPM										1	1
	Outside thread	7/16 -20 UNF sealing cone										2	1
		1/4 -18 NPT										3	1
		G 1/4 sealed at back DIN 3852-E with profile seal ring in FPM										4	1
		G 1/4 sealed at back and manometer with profile seal ring in FPM										5	1
		R 1/4 acc. to EN 10226										7	1
		G 1/2 sealed at back and manometer with profile seal ring in FPM						0,1				8	1
		7/16-20 UNF sealed at back SAE 4 with O-Ring seal FPM										G	1
		1/8 - 27 NPT										A	1
		G 1/8 sealed at front										M	1
		G 1/8 sealed at back DIN 3852-E with Profile seal ring in FPM						0,1				H	1
		G 1/4 sealed at front										J	
		G 1/2 sealed at back DIN 3852-E with profile seal ring in FPM						0,1				C	1
M10x1 sealed at back DIN 3852-E with profile seal ring in FPM						0,1				F	1		
M20x1.5 sealed at front and manometer (combi)										E	1		
G 1/2 sealed at front										9			
Pressure orifice	without											1	
	with											2	
Material pressure connection	Stainless steel 1.4404 / AISI 316L												1
	PVDF outside thread ³⁾ sealed at front G 1/4, G 1/2 ≤ 200 psi										J,9	1	2
Pressure range variation (optional)	Indicate W and state range on order (e.g.: W0... + 16psi/OUT0...5V)												
													W

¹⁾ Other pressure ranges or pressure connections on request

²⁾ Delivery without female connector

³⁾ Medium temperature -15 ... +85 °C

Order code selection in MPa			1	2	3	4	5	6	7	8	9	10	11	
			528.	X	X	X	X	X	X	X	X	X	X	
Pressure range (relative) ¹⁾	-0.1 ... 0 MPa		9	G	0									
	0 ... 0.1 MPa		9	G	1									
	0 ... 0.16 MPa		9	G	2									
	0 ... 0.25 MPa		9	G	4		0,4							
	0 ... 0.4 MPa		9	G	5		0,4							
	0 ... 0.6 MPa		9	G	7		0,4							
	0 ... 1 MPa		9	H	0		0,4							
	0 ... 1.6 MPa		9	H	1		0,4							
	0 ... 2.5 MPa		9	H	2		0,4						1	
	0 ... 4 MPa		9	H	3		0,4						1	
0 ... 6 MPa		9	K	0		0,4						1		
Pressure range (absolute) ¹⁾	0 ... 0.1 MPa		8	G	1									
	0 ... 0.16 MPa		8	G	2									
	0 ... 0.25 MPa		8	G	4									
	0 ... 0.4 MPa		8	G	5									
	0 ... 0.6 MPa		8	G	7									
	0 ... 1 MPa		8	H	0									
0 ... 1.6 MPa		8	H	1										
Sealing material	FPM	Fluoro elastomer (Ⓢ -15 ... +120 °C)					0							
	EPDM	Ethylene propylene (Ⓢ -30 ... +120 °C)					1							
	NBR	Butadiene Acrylonitrile					2							
	MVQ	Silicone polymer (Ⓢ -30 ... +120 °C)					3							
	FPM	Fluoro elastomer (Ⓢ -30 ... +120 °C)					5							
Application	standard						0							
	for oxygen applications						0	1				1	1	
	with drinking water approval NSF 61						0	4				1	1	
Output / power supply	0 ... 5 V	7 ... 33 VDC						1						
	1 ... 6 V	8 ... 33 VDC						6						
		12 ... 33 VDC						2						
	0 ... 10 V	12 ... 33 VDC Enhanced EMC protection						C	1,2,3					
		12 ... 33 VDC / 24 VAC ±15% (not possible with M12x1, metri Pack, RAST, braids)						8						
	ration. 10 ... 90%	5VDC ±10%						7						
		5VDC ±10% Ex protection					0,4	9	1,3				1	
		7 ... 33 VDC						3						
	4 ... 20 mA	7 ... 33 VDC Enhanced EMC protection (not possible with Braids)						A						
		10 ... 30 VDC Ex protection					0,4	4	1,3				1	
Electrical connection	Connector ²⁾	DIN EN 175301-803-A										1		
		DIN EN 175301-803-C (industrial standard 9.4 mm)										2		
		M12x1 2w: IN=1 / OUT=3 3w: IN=1 / OUT=4 / GND=3										3		
		M12x1 2w: IN=1 / OUT=4 3w: IN=1 / OUT=3 / GND=4										M		
		M12x1 2w: IN=1 / OUT=2 3w: IN=1 / OUT=2 / GND=3										P		
		RAST 2.5						0,4	7	4				
	Braids	Metri Pack Serie 150						0,4		5				
		80 ±10 mm								6				
		290 ±10 mm								7				
		480 ±10 mm								8				
	Swift connector	730 ±10 mm								9				
		without cable								0				
		with cable 1.5 m								L				
with cable 2.0 m									N					
with cable 3.0 m									Q					
	with cable 5.0 m								R					
Pressure connection ³⁾	Inside thread	7/16-20 UNF sealing cone										K	1	
		1/2 -14 NPT										D	1	
		G 1/4 with O-Ring seal FPM										1	1	
	Outside thread	7/16 -20 UNF sealing cone											2	1
		1/4 -18 NPT											3	1
		G 1/4 sealed at back DIN 3852-E with profile seal ring in FPM											4	1
		G 1/4 sealed at back and manometer with profile seal ring in FPM											5	1
		R 1/4 acc. to EN 10226											7	1
		G 1/2 sealed at back and manometer with profile seal ring in FPM						0,1					8	1
		7/16-20 UNF sealed at back SAE 4 with O-Ring seal FPM											G	1
		1/8 - 27 NPT											A	1
		G 1/8 sealed at front											M	1
		G 1/8 sealed at back DIN 3852-E with Profile seal ring in FPM						0,1					H	1
		G 1/4 sealed at front											J	
		G 1/2 sealed at back DIN 3852-E with profile seal ring in FPM						0,1					C	1
		M10x1 sealed at back DIN 3852-E with profile seal ring in FPM						0,1					F	1
M20x1.5 sealed at front and manometer (combi)											E	1		
G 1/2 sealed at front											9			
Pressure orifice	without											1		
	with											2		
Material pressure connection	Stainless steel 1.4404 / AISI 316L												1	
	PVDF outside thread ³⁾ sealed at front G 1/4, G 1/2 ≤ 1.6 MPa										J,9	1	2	
Pressure range variation (optional)	Indicate W and state range on order (e.g.: WO... + 0.3MPa/OUT0...5V)												W	

¹⁾ Other pressure ranges or pressure connections on request

²⁾ Delivery without female connector

³⁾ Medium temperature -15 ... +85 °C

Swift connector	117312
Female connector DIN EN 175301-803-A with seal	103510
Female connector DIN EN 175301-803-C with seal	104244
Corner-wire box for connector M12x1	106975
Corner-wire box for connector M12x1 with cable 2.0 m	114604
Straight-wire box for connector M12x1	114570
Straight-wire box for connector M12x1 with cable 2.0 m	114605
Mounting bracket with screw	118716
Heat sink with outside thread G ½ sealed at front - inside thread G ½	105631
Heat sink with outside thread G ½ sealed at front - inside thread G ¼	105073
Heat sink with outside thread G ¼ sealed at front - inside thread G ¼	105074
Calibration certificate	104551

Mounting bracket with screw

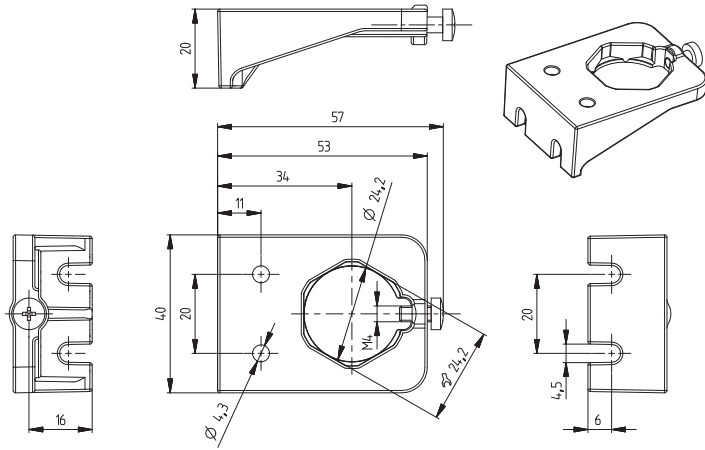

Heat sink

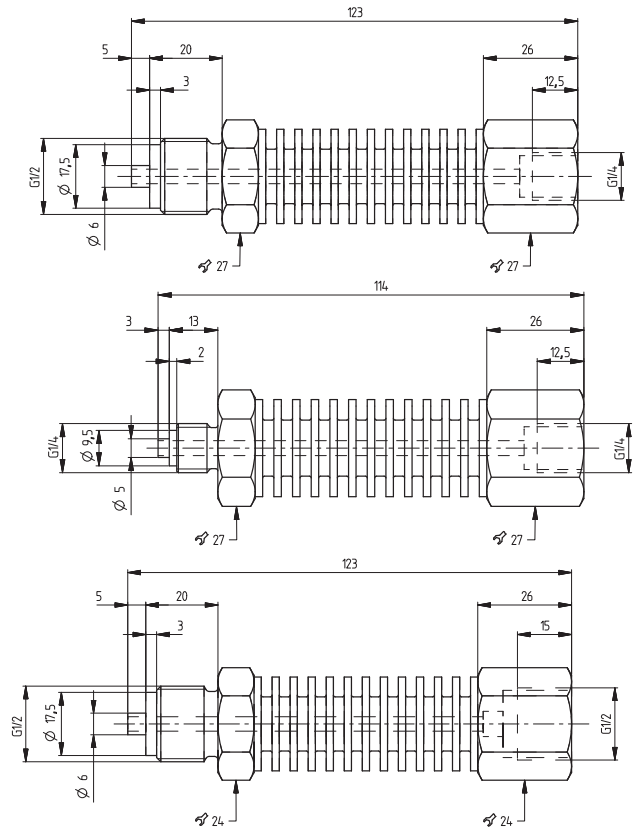

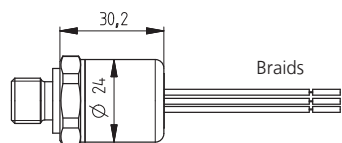
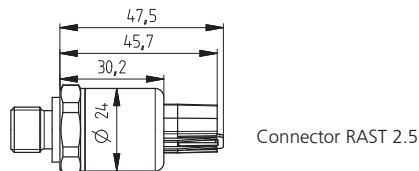
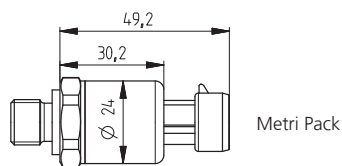
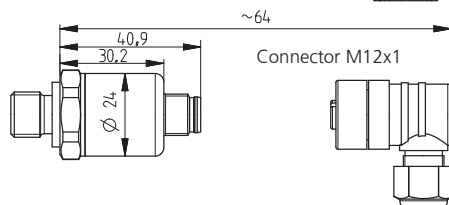
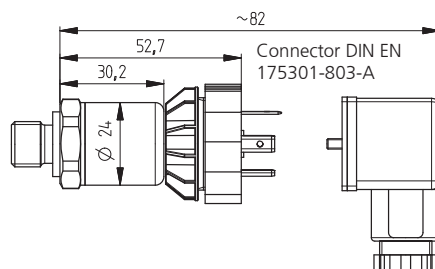
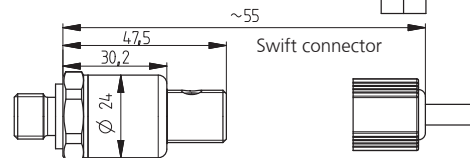
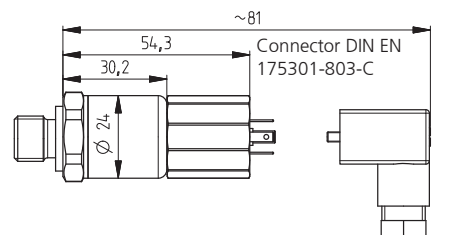
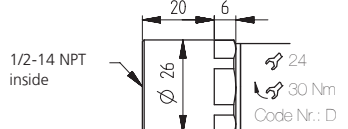
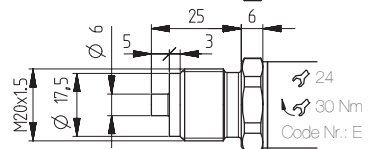
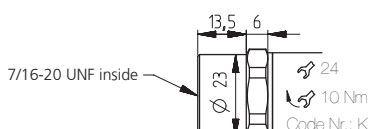
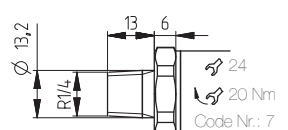
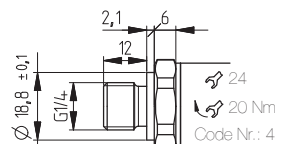
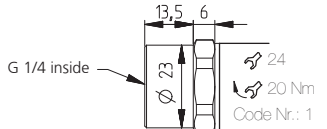
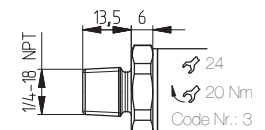
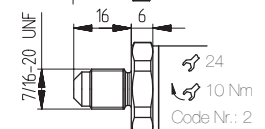
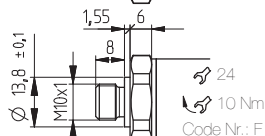
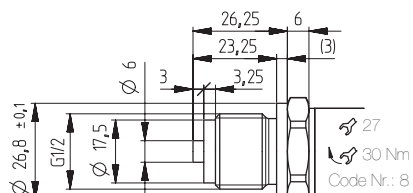
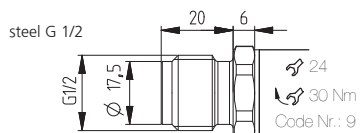
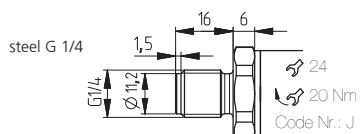
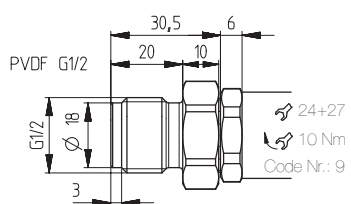
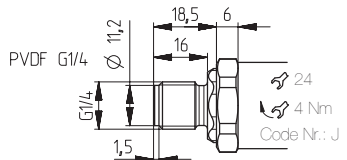
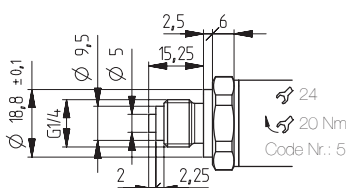
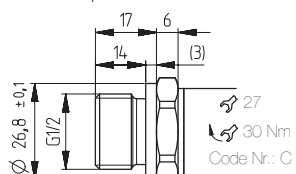
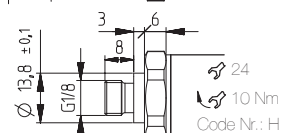
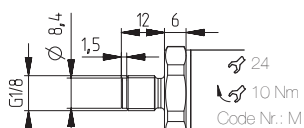
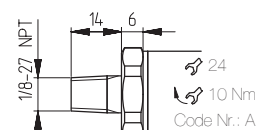
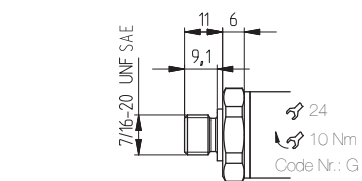

2 wire

Connector DIN
EN 175301-803-A or C

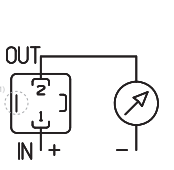

1 (IN) 2 (OUT)

Swift connector

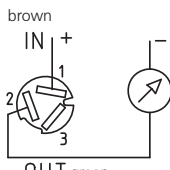

1 (IN) 2 (OUT)

Connector M12x1

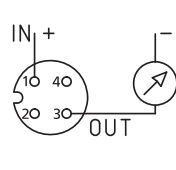

1 (IN) 3 (OUT)

Connector M12x1

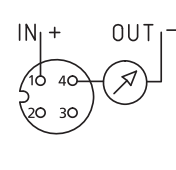

1 (IN) 4 (OUT)

Connector M12x1

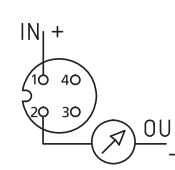

1 (IN) 2 (OUT)

Metri Pack Serie 150

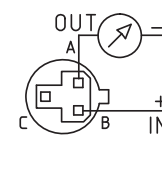

B (IN) A (OUT)

Braids

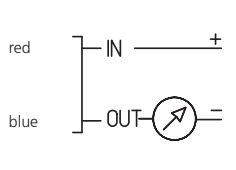

3 wire

Connector DIN
EN 175301-803-A or C

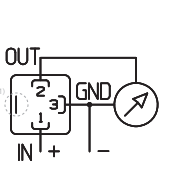

1 (IN) 2 (OUT) 3 (GND)

Swift connector

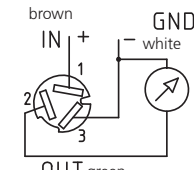

1 (IN) 2 (OUT) 3 (GND)

Connector M12x1

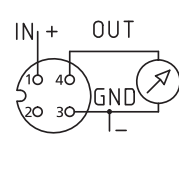

1 (IN) 4 (OUT) 3 (GND)

Connector M12x1

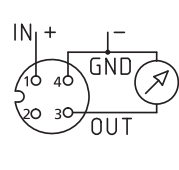

1 (IN) 3 (OUT) 4 (GND)

Connector M12x1

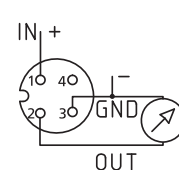

1 (IN) 2 (OUT) 3 (GND)

Metri Pack Serie 150

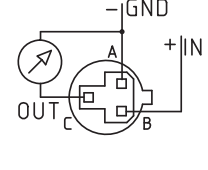

B (IN) C (OUT) A (GND)

Braids

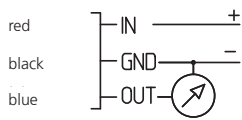

Connector RAST 2.5

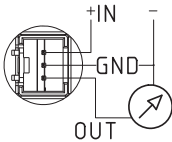

Device design with explosion protection: 4 ... 20 mA
The grounding connection is conductively connected to the transmitter housing.

Connector DIN
EN 175301-803-A

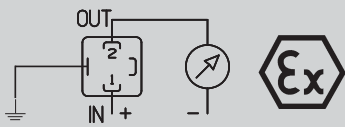

1 (IN) 2 (OUT) ↓

Connector M12x1

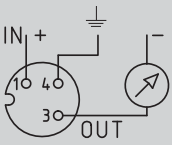

1 (IN) 3 (OUT) 4 (↓)

Device design with explosion protection: ratiom. 10 ... 90%
The electronic GND is connected with a 1MΩ resistor to the transmitter housing.

Connector DIN
EN 175301-803-A

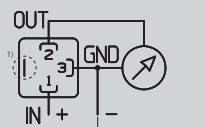

1 (IN) 2 (OUT) 3 (GND)

Connector M12x1

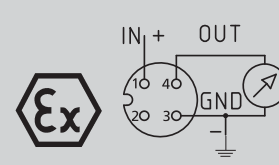

1 (IN) 3 (GND) 4 (OUT)

¹⁾ Not connected with transmitter housing

Huba Control AG

Headquarters

Industriestrasse 17
5436 Würenlos
Telefon +41 (0) 56 436 82 00
Telefax +41 (0) 56 436 82 82
info.ch@hubacontrol.com

Huba Control AG

Niederlassung Deutschland

Schlattgrabenstrasse 24
72141 Walddorfhäslach
Telefon +49 (0) 7127 23 93 00
Telefax +49 (0) 7127 23 93 20
info.de@hubacontrol.com

Huba Control SA

Succursale France

Rue Lavoisier
Technopôle Forbach-Sud
57602 Forbach Cedex
Téléphone +33 (0) 387 847 300
Télécopieur +33 (0) 387 847 301
info.fr@hubacontrol.com

Huba Control AG

Vestiging Nederland

Hamseweg 20A
3828 AD Hoogland
Telefoon +31 (0) 33 433 03 66
Telefax +31 (0) 33 433 03 77
info.nl@hubacontrol.com

Huba Control AG

Branch Office United Kingdom

Unit 13 Berkshire House
County Park Business Centre
Shrivenham Road
Swindon Wiltshire SN1 2NR
Phone +44 (0) 1993 776667
Fax +44 (0) 1993 776671
info.uk@hubacontrol.com