



Pressure transmitter

# Huba Control

## Relative and absolute pressure transmitter Type 528



The compact type 528 pressure transmitter is based upon the well proven ceramic technology developed by Huba Control over 20 years ago.

These transmitters are suitable for applications across a broad spectrum of industries.

**Pressure range**  
**-1 ... 0 – 60 bar**

- + Compact, rugged construction
- + Negligible temperature influence on accuracy
- + Large selection of connections available
- + Saving time by quick cable mounting by the customer with swift connector

## Technical overview

### Pressure range

Relative	-1 ... 0 – 60 bar
Absolute	0 ... 1 – 16 bar

### Operating conditions

Medium			Liquids and gases
Temperature	Medium	FPM	-15 ... +125 °C (-15 ... +120 °C)
		EPDM	-40 ... +125 °C (-30 ... +120 °C)
		NBR	-20 ... +100 °C
		MVQ	-40 ... +125 °C (-30 ... +120 °C)
		FPM	-40 ... +125 °C (-30 ... +120 °C)
			Ambient
Tolerable overload / Rupture pressure	Storage	-50 ... +100 °C	
		≤ 4 bar	3.0 x fs
		> 4 bar	2.5 x fs

### Materials

Cover	Stainless steel 1.4404 / AISI 316L	
Plug accommodation	Polyarylamide 50% GF UL 94 V-0	
Materials in contact with medium	Pressure connection	Stainless steel 1.4404 / AISI 316L
		PVDF
	Sensor	Ceramic Al <sub>2</sub> O <sub>3</sub> (96%)
	Sealing material	FPM, EPDM, NBR, MVQ

### Electrical overview

2 wire	Output	Power supply	Load	Current consumption
	4 ... 20 mA	7 ... 33 VDC	< $\frac{\text{supply voltage} - 2V}{0.02 A}$ [Ohm]	< 23 mA
3 wire	4 ... 20 mA	10 ... 30 VDC	< $\frac{\text{supply voltage} - 10V}{0.02 A}$ [Ohm]	< 23 mA
	0 ... 5 V	7 ... 33 VDC	>10 kOhm / < 100 nF	< 7 mA
	1 ... 6 V	8 ... 33 VDC	>10 kOhm / < 100 nF	< 7 mA
	0 ... 10 V	12 ... 33 VDC	>10 kOhm / < 100 nF	< 7 mA
	0 ... 10 V	12 ... 33 VDC / 24 VAC ± 15%	>10 kOhm / < 100 nF	< 7 mA
	ration. 10 ... 90%	5 VDC ± 10%	>10 kOhm / < 100 nF	< 7 mA
	ration. 10 ... 90%	5 VDC ± 10%	>10 kOhm / < 100 nF	< 7 mA
Polarity reversal protection	Short circuit proof and protected against polarity reversal. Each connection is protected against crossover up to max. supply voltage.			
Insulation voltage	500 VDC			

### Dynamic response

Response time	< 2 ms, 1 ms typ.
Load cycle	< 100 Hz

### Electrical connection

	Protection standard	Protection class
Swift connector with or without cable 1.5 / 2.0 / 3.0 / 5.0 m (PVC spec.)	IP 67	III
Connector DIN EN 175301-803-A or C (industrial standard 9.4 mm)	IP 65	III
Metri Pack 150 P2S Series	IP 67	III
Connector M12x1	IP 67	III
Braids	IP 65	III
Connector RAST 2.5 (3 wire, only)	IP 00	III

### Pressure connection

Inside thread	7/16 - 20 UNF	
	1/2 - 14 NPT	
Outside thread	G 1/4	with O-Ring seal FPM (-30 ... +135 °C)
	7/16 - 20 UNF	sealing cone 45°
	1/4 - 18 NPT	
	7/16 - 20 UNF	sealed at back SAE 4 with O-Ring seal FPM (-20 ... +135 °C)
	G 1/4, G 1/2, G 3/8	sealed at back ISO 1179-2 (DIN 3852-E) with Profile seal ring in FPM (-30 ... +135 °C)
	G 1/4, G 1/2	sealed at back and manometer (combi) with Profile seal ring in FPM (-30 ... +135 °C)
	G 1/4	sealed at back DIN 3852-2 Form A
	R 1/4	EN 10226
	1/8 - 27 NPT	
	G 1/8	sealed at front or sealed at back and manometer (combi) with Profile seal ring in FPM (-30 ... +135 °C)
M10x1	sealed at back ISO 9974-2 (DIN 3852-E) with Profile seal ring in FPM (-30 ... +135 °C)	
M20x1.5	sealed at front and manometer (combi)	
G 1/4, G 1/2	sealed at front	

### Installation arrangement

Unrestricted	<b>Recommendation:</b> Pressure connection facing downwards
--------------	---

### Tests / Admissions

Electromagnetic compatibility	CE conformity acc. EN 61326-2-3
Enhanced EMC protection	EN 50121-3-2
Shock acc. IEC 68-2-27	100 g, 11 ms half sine wave, all 6 directions, free fall from 1 m on concrete (6x)
Constant shock acc. IEC 68-2-29	40 g for 6 ms, 1000x all 3 directions
Vibration acc. IEC 68-2-6	20 g, 15 ... 2000 Hz, 15 ... 25 Hz with amplitude ± 15 mm, 1 Octave/min. all 3 directions, 50 constant load
UL	ANSI/UL 61010-1 acc. E325110
Drinking water approval	NSF/ANSI 61/372 acc. MH60087
EAC	

### Protection against explosion

	ration. 10 ... 90%	4 ... 20 mA
Intrinsic safety «i»	Ex II 1/2 G Ex ia IIC T4 Ga/Gb	Ex II 1/2 G Ex ia IIC T4 Ga/Gb
EC type examination certificate	Ex II 1/2 D Ex ia IIC T125°C Da/Db	Ex II 1/2 D Ex ia IIC T125°C Da/Db
Connection to certified intrinsically safe resistive circuits with maximum values	SEV 15 ATEX 0173	SEV 10 ATEX 0145
Effective internal inductance and capacitance for versions with plugs complying with EN 175301-803-A or M12x1	Ui ≤ 15 VDC; Ii ≤ 200 mA; Pi ≤ 750 mW	Ui ≤ 30 VDC; Ii ≤ 100 mA; Pi ≤ 750 mW
IECEX	Li = 0 nH; Ci ≤ 150 nF	Li = 0 nH; Ci = 0 nF
		SEV 16.0007

### Weight

- 90 g

### Packaging (Please state on order)

Single packaging in cardboard	accessories integrated
Multiple packaging in cardboard (25 pcs)	

# Accuracy

Parameter	Unit	
Characteristic line a <sup>1)</sup>	% fs	± 0.3
Resolution	% fs	0.1
Thermal characteristic <sup>2)</sup>	max. % fs/10K	± 0.2
Long term stability acc. EN 60770-1	max. % fs	± 0.25

Test conditions: 25 °C, 45% RH, power supply 24 VDC

## Order code selection in bar

			1	2	3	4	5	6	7	8	9	10	11		
			528.	X	X	X	X	X	X	X	X	X	X		
Pressure range (relative) <sup>3)</sup>	-1 ... 0 bar		9	0	1										
	0 ... 1 bar		9	1	1										
	0 ... 1.6 bar		9	1	2										
	0 ... 2.5 bar		9	1	4		0,4								
	0 ... 4 bar		9	1	5		0,4								
	0 ... 6 bar		9	1	7		0,4								
	0 ... 10 bar		9	3	0		0,4								
	0 ... 16 bar		9	3	1		0,4								
	0 ... 25 bar		9	3	2		0,4					1			
	0 ... 40 bar		9	3	3		0,4					1			
0 ... 60 bar		9	4	0		0,4					1				
Pressure range (absolute) <sup>3)</sup>	0 ... 1 bar		8	1	1										
	0 ... 1.6 bar		8	1	2										
	0 ... 2.5 bar		8	1	4										
	0 ... 4 bar		8	1	5										
	0 ... 6 bar		8	1	7										
	0 ... 10 bar		8	3	0										
Sealing material	FPM	Fluoro elastomer (⊖ -15 ... +120 °C)					0								
	EPDM	Ethylene propylene (⊖ -30 ... +120 °C)					1								
	NBR	Butadiene Acrylonitrile					2								
	MVQ	Silicone polymer (⊖ -30 ... +120 °C)					3								
	FPM	Fluoro elastomer (⊖ -30 ... +120 °C)					5								
Application	standard						0								
	for oxygen applications						0	1				1	1		
	with drinking water approval NSF 61						0	4				1	1		
Output / power supply	0 ... 5 V	7 ... 33 VDC						1							
	1 ... 6 V	8 ... 33 VDC						6							
	0 ... 10 V	12 ... 33 VDC							2						
		12 ... 33 VDC Enhanced EMC protection							C	1,2,3					
		12 ... 33 VDC / 24 VAC ±15% (not possible with M12x1, metri Pack, RAST, braids)							8						
	ration. 10 ... 90%	5VDC ±10% Ex protection					0,4	9	1,3			1			
	4 ... 20 mA	7 ... 33 VDC							3						
		7 ... 33 VDC Enhanced EMC protection (not possible with Braids)							A						
		10 ... 30 VDC Ex protection						0,4	4	1,3			1		
	Electrical connection	Connector <sup>4)</sup>	DIN EN 175301-803-A											1	
DIN EN 175301-803-C (industrial standard 9.4 mm)														2	
M12x1 2w: IN=1 / OUT=3 3w: IN=1 / OUT=4 / GND=3															3
M12x1 2w: IN=1 / OUT=4 3w: IN=1 / OUT=3 / GND=4															M
M12x1 2w: IN=1 / OUT=2 3w: IN=1 / OUT=2 / GND=3															P
RAST 2.5								0,4	7	4					
Braids		Metri Pack 150 P2S Series						0,4		5					
		80 ±10 mm								6					
		290 ±10 mm								7					
		480 ±10 mm								8					
		730 ±10 mm								9					
Swift connector		without cable								0					
		with cable 1.5 m								L					
		with cable 2.0 m								N					
		with cable 3.0 m								Q					
	with cable 5.0 m								R						
Pressure connection <sup>3)</sup>	Inside thread	7/16-20 UNF sealing cone											K	1	
		1/2 -14 NPT												D	1
		G 1/4 with O-Ring seal FPM												1	1
	Outside thread	7/16-20 UNF sealing cone												2	1
		1/4 -18 NPT												3	1
		G 1/4 sealed at back ISO 1179-2 (DIN 3852-E) with profile seal ring in FPM												4	1
		G 1/4 sealed at back and manometer with profile seal ring in FPM												5	1
		R 1/4 acc. to EN 10226												7	1
		G 1/2 sealed at back and manometer with profile seal ring in FPM						0,1						8	1
		7/16-20 UNF sealed at back SAE 4 with O-Ring seal FPM						0,1						G	1
		1/8 - 27 NPT												A	1
		G 1/8 sealed at front												M	1
		G 1/8 sealed at back ISO 1179-2 (DIN 3852-E) with Profile seal ring in FPM						0,1						H	1
		G 1/4 sealed at front												J	
		G 1/4 sealed at back DIN 3852-2 Form A <sup>5)</sup>												S	1
G 1/2 sealed at back ISO 1179-2 (DIN 3852-E) with profile seal ring in FPM						0,1						C	1		
M10x1 sealed at back ISO 9974-2 (DIN 3852-E) with profile seal ring in FPM						0,1						F	1		
M20x1.5 sealed at front and manometer (combi)												E	1		
G 1/2 sealed at front												9			
Pressure orifice	without												1		
	with												2		
Material	Stainless steel 1.4404 / AISI 316L													1	
pressure connection	PVDF outside thread <sup>6)</sup>	sealed at front G 1/4, G 1/2									J,9	1	2		
Pressure range variation (optional)	Indicate W and state range on order (e.g.: W0... +3bar/OUT0...5V)													W	

<sup>1)</sup> typ. ; max. 0.5% fs (incl. zero point, full scale, linearity, hysteresis and repeatability)

<sup>2)</sup> -15 ... 85 °C

<sup>3)</sup> Other pressure ranges or pressure connections on request

<sup>4)</sup> Delivery without female connector

<sup>5)</sup> without UL-Admission

<sup>6)</sup> Medium temperature -15 ... +85 °C





			1	2	3	4	5	6	7	8	9	10	11		
<b>Order code selection in psi</b>			528.	X	X	X	X	X	X	X	X	X	X		
<b>Pressure range (relative) <sup>1)</sup></b>	-30 ... 0" hg		9	B	0										
	0 ... 15 psi		9	B	1										
	0 ... 20 psi		9	B	2										
	0 ... 30 psi		9	B	4		0,4								
	0 ... 60 psi		9	B	5		0,4								
	0 ... 100 psi		9	B	7		0,4								
	0 ... 150 psi		9	C	0		0,4								
	0 ... 200 psi		9	C	1		0,4								
	0 ... 300 psi		9	C	2		0,4						1		
	0 ... 500 psi		9	C	3		0,4						1		
0 ... 750 psi		9	D	0		0,4						1			
<b>Pressure range (absolute) <sup>1)</sup></b>	0 ... 15 psi		8	B	1										
	0 ... 20 psi		8	B	2										
	0 ... 30 psi		8	B	4										
	0 ... 60 psi		8	B	5										
	0 ... 100 psi		8	B	7										
	0 ... 150 psi		8	C	0										
<b>Sealing material</b>	FPM	Fluoro elastomer						0							
	EPDM	Ethylene propylene						1							
	NBR	Butadiene Acrylonitrile						2							
	MVQ	Silicone polymer						3							
	FPM	Fluoro elastomer						5							
<b>Application</b>	standard							0							
	for oxygen applications							0	1			1	1		
	with drinking water approval NSF 61							0	4			1	1		
<b>Output / power supply</b>	0 ... 5 V	7 ... 33 VDC											1		
	1 ... 6 V	8 ... 33 VDC											6		
	0 ... 10 V	12 ... 33 VDC												2	
		12 ... 33 VDC Enhanced EMC protection												C	
		12 ... 33 VDC / 24 VAC ±15% (not possible with M12x1, metri Pack, RAST, braids)												8	
	ratiom. 10 ... 90%	5VDC ±10%												7	
		5VDC ±10% Ex protection						0,4			1,3			9	
	4 ... 20 mA	7 ... 33 VDC												3	
		7 ... 33 VDC Enhanced EMC protection (not possible with Braids)												A	
		10 ... 30 VDC Ex protection						0,4			1,3			4	
<b>Electrical connection</b>	Connector <sup>2)</sup>	DIN EN 175301-803-A											1		
		DIN EN 175301-803-C (industrial standard 9.4 mm)											2		
		M12x1 2w: IN=1 / OUT=3 3w: IN=1 / OUT=4 / GND=3												3	
		M12x1 2w: IN=1 / OUT=4 3w: IN=1 / OUT=3 / GND=4												M	
		M12x1 2w: IN=1 / OUT=2 3w: IN=1 / OUT=2 / GND=3												P	
	Braids	RAST 2.5						0,4		7				4	
		Metri Pack 150 P2S Series						0,4						5	
		80 ±10 mm												6	
		290 ±10 mm												7	
		480 ±10 mm												8	
	Swift connector	730 ±10 mm												9	
		without cable												0	
		with cable 1.5 m												L	
		with cable 2.0 m												N	
		with cable 3.0 m												Q	
<b>Pressure connection <sup>3)</sup></b>	Inside thread	with cable 5.0 m											R		
		7/16"-20 UNF sealing cone												K	
		1/2 -14 NPT												D	
	Outside thread	G 1/4 with O-Ring seal FPM												1	
		7/16"-20 UNF sealing cone												2	
		1/4 -18 NPT												3	
		G 1/4 sealed at back ISO 1179-2 (DIN 3852-E) with profile seal ring in FPM												4	
		G 1/4 sealed at back and manometer with profile seal ring in FPM												5	
		R 1/4 acc. to EN 10226												7	
		G 1/2 sealed at back and manometer with profile seal ring in FPM							0,1					8	
		7/16"-20 UNF sealed at back SAE 4 with O-Ring seal FPM							0,1						G
		1/8 -27 NPT													A
		G 1/8 sealed at front													M
		G 1/8 sealed at back ISO 1179-2 (DIN 3852-E) with Profile seal ring in FPM							0,1						H
		G 1/4 sealed at front													J
		G 1/4 sealed at back DIN 3852-2 Form A <sup>3)</sup>													S
		G 1/2 sealed at back ISO 1179-2 (DIN 3852-E) with profile seal ring in FPM							0,1						C
		M10x1 sealed at back ISO 9974-2 (DIN 3852-E) with profile seal ring in FPM							0,1						F
M20x1.5 sealed at front and manometer (combi)													E		
G 1/2 sealed at front													9		
<b>Pressure orifice</b>	without												1		
	with												2		
<b>Material pressure connection</b>	Stainless steel 1.4404 / AISI 316L												1		
	PVDF outside thread <sup>4)</sup>	sealed at front G 1/4, G 1/2									J,9	1	2		
<b>Pressure range variation (optional)</b>	Indicate W and state range on order (e.g.: W0... +16psi/OUT0...5V)												W		

<sup>1)</sup> Other pressure ranges or pressure connections on request

<sup>2)</sup> Delivery without female connector

<sup>3)</sup> without UL-Admission

<sup>4)</sup> Medium temperature -15 ... +85 °C

				1	2	3	4	5	6	7	8	9	10	11			
<b>Order code selection in MPa</b>				528.	X	X	X	X	X	X	X	X	X	X			
<b>Pressure range (relative) <sup>1)</sup></b>	-0.1 ... 0 MPa			9	G	0											
	0 ... 0.1 MPa			9	G	1											
	0 ... 0.16 MPa			9	G	2											
	0 ... 0.25 MPa			9	G	4		0,4									
	0 ... 0.4 MPa			9	G	5		0,4									
	0 ... 0.6 MPa			9	G	7		0,4									
	0 ... 1 MPa			9	H	0		0,4									
	0 ... 1.6 MPa			9	H	1		0,4									
	0 ... 2.5 MPa			9	H	2		0,4						1			
	0 ... 4 MPa			9	H	3		0,4						1			
<b>Pressure range (absolute) <sup>1)</sup></b>	0 ... 6 MPa			9	K	0		0,4						1			
	0 ... 0.1 MPa			8	G	1											
	0 ... 0.16 MPa			8	G	2											
	0 ... 0.25 MPa			8	G	4											
	0 ... 0.4 MPa			8	G	5											
	0 ... 0.6 MPa			8	G	7											
	0 ... 1 MPa			8	H	0											
<b>Sealing material</b>	FPM	Fluoro elastomer	(  -15 ... +120 °C)				0										
	EPDM	Ethylene propylene	(  -30 ... +120 °C)				1										
	NBR	Butadiene Acrylonitrile					2										
	MVQ	Silicone polymer	(  -30 ... +120 °C)				3										
	FPM	Fluoro elastomer	(  -30 ... +120 °C)				5										
<b>Application</b>	standard						0										
	for oxygen applications						0	1					1	1			
	with drinking water approval NSF 61						0	4					1	1			
<b>Output / power supply</b>	0 ... 5 V	7 ... 33 VDC							1								
	1 ... 6 V	8 ... 33 VDC							6								
	0 ... 10 V	12 ... 33 VDC								2							
		12 ... 33 VDC Enhanced EMC protection								C	1,2,3						
		12 ... 33 VDC / 24 VAC ±15% (not possible with M12x1, metri Pack, RAST, braids)								8							
	ratiom. 10 ... 90%	5VDC ±10%								7							
		5VDC ±10% Ex protection					0,4			9	1,3			1			
	4 ... 20 mA	7 ... 33 VDC								3							
		7 ... 33 VDC Enhanced EMC protection (not possible with Braids)								A							
		10 ... 30 VDC Ex protection					0,4			4	1,3			1			
<b>Electrical connection</b>	Connector <sup>2)</sup>	DIN EN 175301-803-A											1				
		DIN EN 175301-803-C (industrial standard 9.4 mm)												2			
		M12x1 2w: IN=1 / OUT=3 3w: IN=1 / OUT=4 / GND=3													3		
		M12x1 2w: IN=1 / OUT=4 3w: IN=1 / OUT=3 / GND=4													M		
		M12x1 2w: IN=1 / OUT=2 3w: IN=1 / OUT=2 / GND=3													P		
		RAST 2.5					0,4		7						4		
	Braids	Metri Pack 150 P2S Series					0,4								5		
		80 ±10 mm													6		
		290 ±10 mm													7		
		480 ±10 mm													8		
		730 ±10 mm													9		
	Swift connector	without cable													0		
		with cable 1.5 m													L		
		with cable 2.0 m													N		
		with cable 3.0 m													Q		
with cable 5.0 m														R			
<b>Pressure connection <sup>3)</sup></b>	Inside thread	7/16"-20 UNF sealing cone												K	1		
		1/2 -14 NPT													D	1	
		G 1/4 with O-Ring seal FPM													1	1	
	Outside thread	7/16"-20 UNF sealing cone													2	1	
		1/4 -18 NPT													3	1	
		G 1/4 sealed at back ISO 1179-2 (DIN 3852-E) with profile seal ring in FPM													4	1	
		G 1/4 sealed at back and manometer with profile seal ring in FPM													5	1	1
		R 1/4 acc. to EN 10226													7	1	
		G 1/2 sealed at back and manometer with profile seal ring in FPM						0,1							8	1	
		7/16"-20 UNF sealed at back SAE 4 with O-Ring seal FPM						0,1							G	1	
		1/8 - 27 NPT													A	1	
		G 1/8 sealed at front													M	1	
		G 1/8 sealed at back ISO 1179-2 (DIN 3852-E) with Profile seal ring in FPM						0,1							H	1	
		G 1/4 sealed at front													J		
		G 1/4 sealed at back DIN 3852-2 Form A <sup>3)</sup>													S	1	
		G 1/2 sealed at back ISO 1179-2 (DIN 3852-E) with profile seal ring in FPM						0,1							C	1	
		M10x1 sealed at back ISO 9974-2 (DIN 3852-E) with profile seal ring in FPM						0,1							F	1	
		M20x1.5 sealed at front and manometer (combi)													E	1	
G 1/2 sealed at front													9				
<b>Pressure orifice</b>	without														1		
	with														2		
<b>Material pressure connection</b>	Stainless steel 1.4404 / AISI 316L														1		
	PVDF outside thread <sup>4)</sup>	sealed at front G 1/4, G 1/2	≤ 1.6 MPa										J,9	1	2		
<b>Pressure range variation (optional)</b>	Indicate W and state range on order (e.g.: W0... + 0.3MPa/OUT0...5V)													W			

<sup>1)</sup> Other pressure ranges or pressure connections on request

<sup>2)</sup> Delivery without female connector

<sup>3)</sup> without UL-Admission

<sup>4)</sup> Medium temperature -15 ... +85 °C

Swift connector	117312
Female connector DIN EN 175301-803-A with seal	103510
Female connector DIN EN 175301-803-C with seal	104244
Corner-wire box for connector M12x1	106975
Corner-wire box for connector M12x1 with cable 2.0 m	114604
Straight-wire box for connector M12x1	114570
Straight-wire box for connector M12x1 with cable 2.0 m	114605
Mounting bracket with screw	118716
Heat sink with outside thread G 1/2 sealed at front - inside thread G 1/2	105631
Heat sink with outside thread G 1/2 sealed at front - inside thread G 1/4	105073
Heat sink with outside thread G 1/4 sealed at front - inside thread G 1/4	105074
Calibration certificate	104551

Mounting bracket with screw

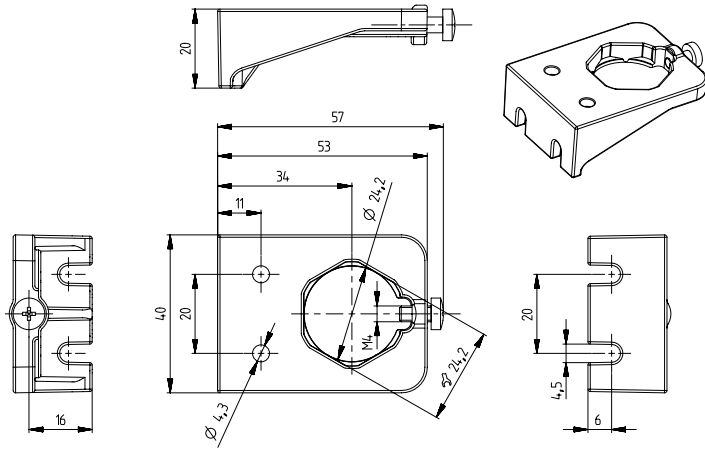

Heat sink

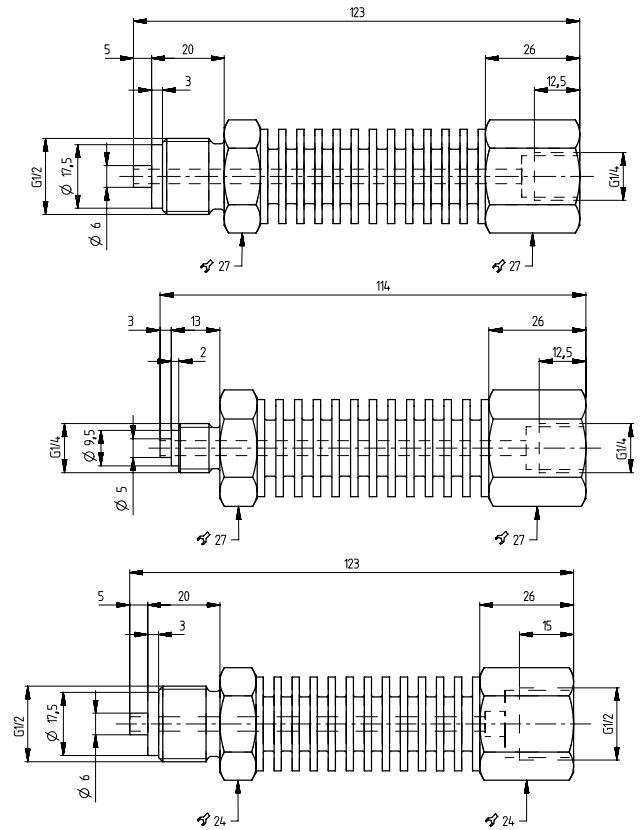

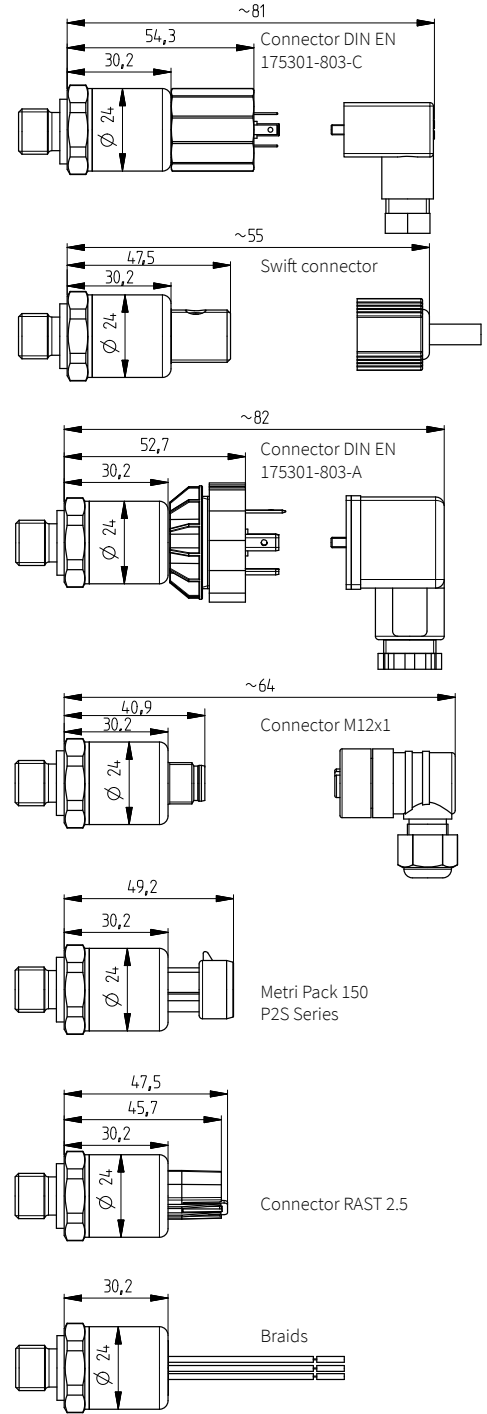
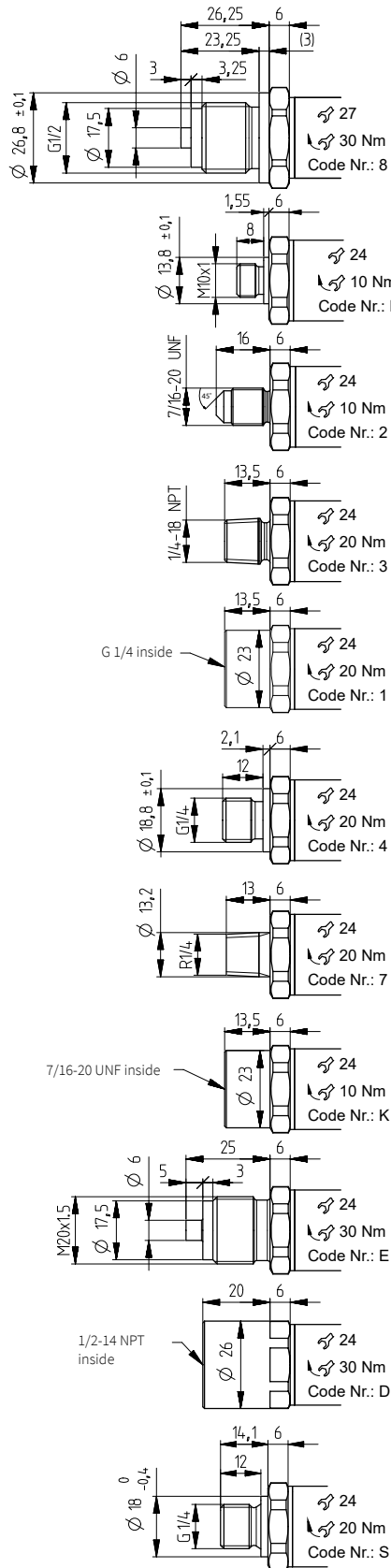
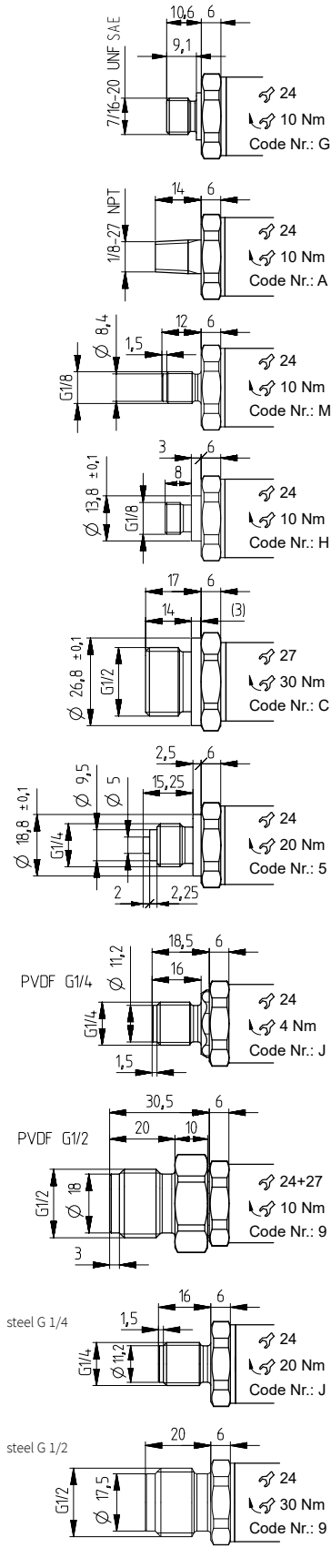

# Electrical connections

## 2 wire

Connector DIN  
EN 175301-803-A or C

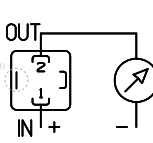

1 (IN) 2 (OUT)

Swift connector

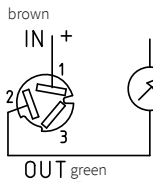

1 (IN) 2 (OUT)

Connector M12x1

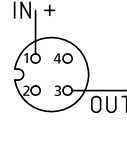

1 (IN) 3 (OUT)

Connector M12x1

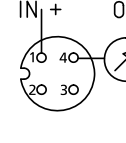

1 (IN) 4 (OUT)

Connector M12x1

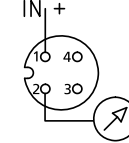

1 (IN) 2 (OUT)

Metri Pack 150 P2S Series

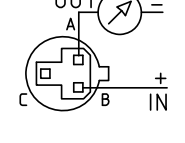

B (IN) A (OUT)

Braids

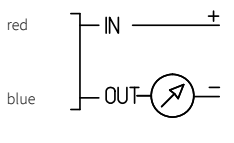

## 3 wire

Connector DIN  
EN 175301-803-A or C

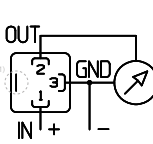

1 (IN) 2 (OUT) 3 (GND)

Swift connector

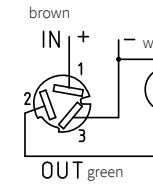

1 (IN) 2 (OUT) 3 (GND)

Connector M12x1

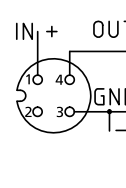

1 (IN) 4 (OUT) 3 (GND)

Connector M12x1

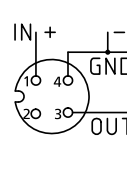

1 (IN) 3 (OUT) 4 (GND)

Connector M12x1

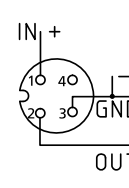

1 (IN) 2 (OUT) 3 (GND)

Metri Pack 150 P2S Series

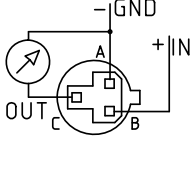

B (IN) C (OUT) A (GND)

Braids

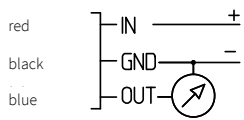

Connector RAST 2.5

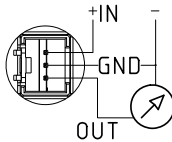

**Device design with explosion protection: 4 ... 20 mA**  
The grounding connection is conductively connected to the transmitter housing.

Connector DIN  
EN 175301-803-A

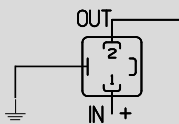

1 (IN) 2 (OUT) ↓



Connector M12x1

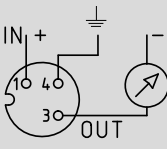

1 (IN) 3 (OUT) 4 (↓)

**Device design with explosion protection: ratiom. 10 ... 90%**  
The electronic GND is connected with a 1MΩ resistor to the transmitter housing.

Connector DIN  
EN 175301-803-A

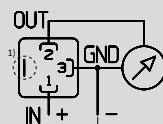

1 (IN) 2 (OUT) 3 (GND)



Connector M12x1

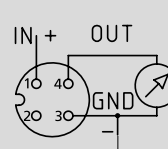

1 (IN) 3 (GND) 4 (OUT)

<sup>1)</sup> Not connected with transmitter housing



**Huba Control AG**

Industriestrasse 17  
5436 Würenlos, Switzerland  
Tel. +41 56 436 82 00  
[info.ch@hubacontrol.com](mailto:info.ch@hubacontrol.com)



Consultancy in your area  
[hubacontrol.com/en/worldwide](https://hubacontrol.com/en/worldwide)

