

OEM Relative pressure transmitter type 503

Pressure range
0 ... 2.5 – 25 bar



Type 503 pressure transmitters, with their excellent price / performance ratio, are specially designed for industrial OEM applications.

Partially automated production techniques allow us to produce high quantities, yet retaining the flexibility to offer different versions.

- Partial automatic production, giving ideal price / performance ratio.
- Ideal for use as a control element, owing as a result of a small hysteresis
- Incorporates all the benefits of ceramics technology for industrial applications

Technical overview

Pressure range

Relative	0 ... 2.5 – 25 bar
----------	--------------------

Operating conditions

Medium	Liquids and neutral gases	
Temperature	Medium	+2 ... +90 °C
	Ambient	+10 ... +60 °C
	Storage	-30 ... +85 °C
Overload admissible	2 x fs	
Rupture pressure	3 x fs (max. 50 bar)	

Materials

Housing material	ABS for cover with connector RAST 2.5	ABS
	PA 6 for cover with connector DIN or cable	PA 6
Materials in contact with the medium	Sensor	Ceramic Al ₂ O ₃ (96%)
	Pressure connector	Grivory GV 5H or Noryl GTX 20% GF
	Sealing material	FPM, EPDM, NBR

Electrical overview

2 wire	Output	4 ... 20 mA	Power supply	10.0 ... 33 VDC	Load	$< \frac{\text{supply voltage} - 10 \text{ V}}{0.02 \text{ A}}$ [Ohm]	Current consumption	< 20 mA
		0 ... 5 V		9.0 ... 33 VDC		> 10 kOhm / < 100 nF		< 5 mA
3 wire		0 ... 10 V		16.2 ... 33 VDC		> 10 kOhm / < 100 nF		< 5 mA
		ration. 10 ... 90%		5 VDC ±5%		> 10 kOhm / < 100 nF		< 5 mA
Polarity reversal protection	Short circuit proof and protected against polarity reversal. For connector versions mechanical protection only. The correct wiring acc. to the scheme has to be guaranteed by the OEM-customer.							
Electromagnetic compatibility	The product is designed exclusively for installation in equipment. The customer is responsible for CE conformity.							

Dynamic response

Response time	< 5 ms
Load cycle	< 50 Hz

Electrical connections

DIN connector EN 175301-803-A	Protection standard	IP 65
Cable 1.5 m		IP 65
Connector RAST 2.5		IP 00

Pressure connections

Outside thread	G 3/8 seal at front	Grivory GV 5H
	G 3/8 seal at back	Grivory GV 5H
Plug connector	G 1/4 seal at back	Grivory GV 5H
	(to max. 6 bar nominal pressure)	Grivory GV 5H

Mounting instructions

Installation arrangement	Unrestricted
Starting torque G 3/8	min. 0.4 Nm / max. 0.8 Nm Destruction > 30 Nm

Weight

With connector RAST 2.5	~ 41 g
With connector DIN	~ 55 g
With cable	~ 95 g

Packaging

Multiple packaging Cardboard boxes with blister pack inserts	per 240 pcs.
	per 600 pcs.

Accuracy

Parameter		Unit	
Tolerance zero point	max.	% fs	± 1.5
Tolerance full scale	max.	% fs	± 1.5
Resolution		% fs	0.1
Total of linearity, hysteresis and repeatability		% fs	± 1.0
Long term stability acc. DIN EN 60770		% fs	± 0.5
TC zero point ¹⁾	max.	% fs/10K	± 0.6
TC sensitivity ¹⁾	max.	% fs/10K	± 0.15

Test conditions: 25 °C, 45% RH, power supply 24 VDC / 5 VDC
TK0 / TKE 2 ... 85 °C

¹⁾ TC = Temperature coefficient

			1	2	3	4	5	6	7	8	9
Order code selection table			503. X X X X X X X X X								
Pressure range ¹⁾	0 ... 2.5 bar		9	1	4						
	0 ... 4 bar		9	1	5						
	0 ... 6 bar		9	1	7						
	0 ... 10 bar		9	3	0						
	0 ... 16 bar		9	3	1						
	0 ... 25 bar		9	3	2						
▲ Fullscale signal at these pressures											
Sealing material ²⁾	FPM	Fluoro-elastomer					0				
	EPDM	Ethylene propylene					1				
	NBR	Butadiene Acrylonitrile					2				
Adjustment	Factory						0				
Output / power supply	0 ... 5 V	9.0 ... 33 VDC							3		
	0 ... 10 V	16.2 ... 33 VDC							4		
	4 ... 20 mA	10.0 ... 33VDC							5		
	ratiom. 10 ... 90%	5 VDC ±5%							6		
Electrical connection ³⁾	Connector	RAST 2.5							6	0	
	Cable 1.5 m	DIN EN 175301-803-A								1	2
Pressure connection	Outside thread	G 3/8, seal at front	Grivory GV 5H	1							0
		G 3/8, seal at back	Grivory GV 5H								1
		G 1/4, seal at back	Grivory GV 5H	3							3
	Plug connector	(to max. 6 bar measuring range)	Noryl GV 5H	1		1					2
Pressure range variation (optional)	Indicate W and state range on order (e.g.: W0... + 9bar/OUT1...9V)										W

Accessories (supplied loose)	Order number
Safety spring for plug connector	105883
Female connector DIN EN 175301-803-A with sealing	103510
Female connector RAST 2.5 with cable 1450 mm	103167
Calibration Certificate	104551

AMP connector ⁴⁾	Manufacturer's Part No.	Colour	For flexible wire
	3-829868-3	grey	7 x 0.20 mm = 0.22 mm ² or 12 x 0.20 mm = 0.35 mm ²
	1-966194-3	beige	7 x 0.25 mm = 0.35 mm ²

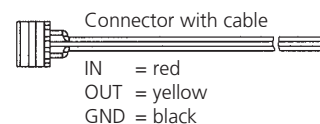

¹⁾ Other pressure ranges on request

²⁾ According to ISO standard R 1629, other sealing materials on request

³⁾ Delivery without female connector

⁴⁾ To be ordered separately from original manufacturer. Further information can be found in the manufacturer specification No. 114-18049

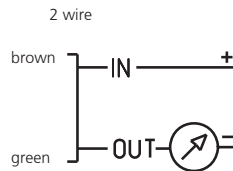
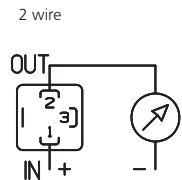
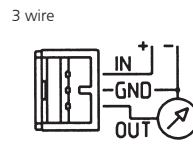
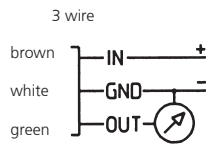
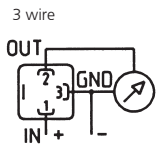
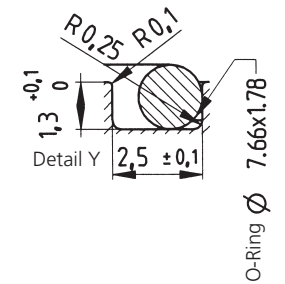
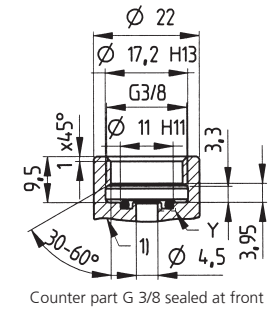
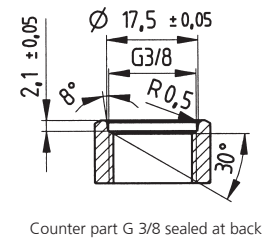
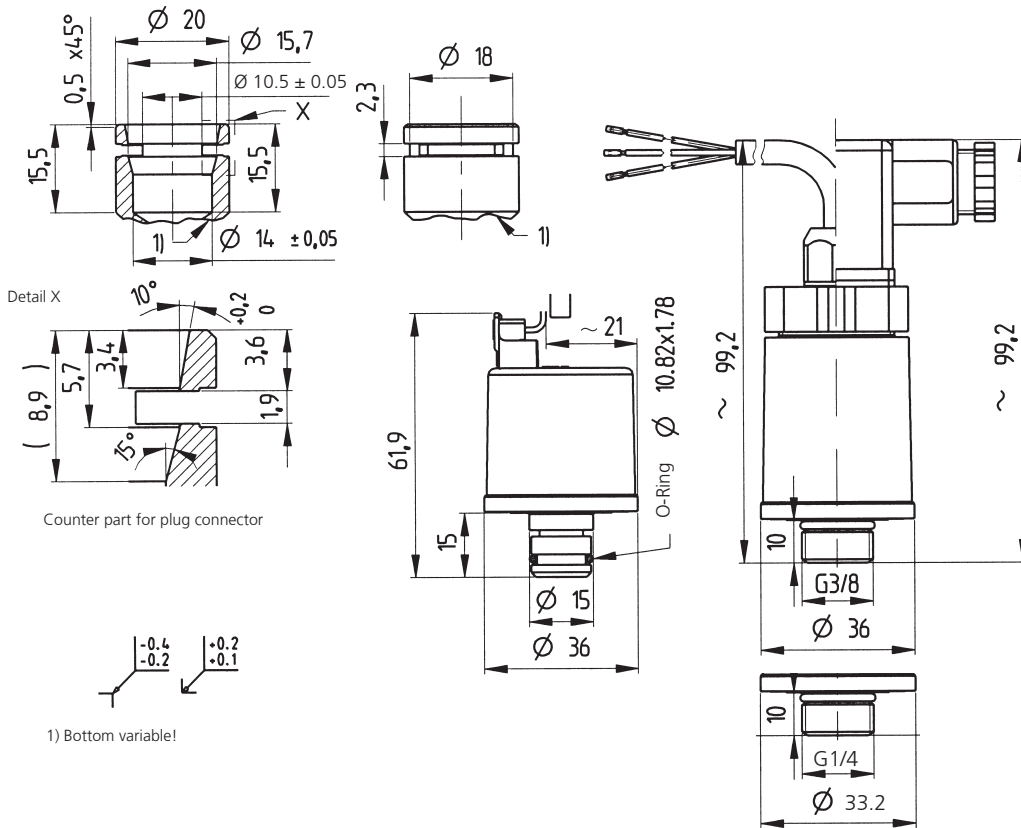

Huba Control AG
Headquarters

Industriestrasse 17
5436 Würenlos
Telefon +41 (0) 56 436 82 00
Telefax +41 (0) 56 436 82 82
info.ch@hubacontrol.com

Huba Control AG
Niederlassung Deutschland

Schlattgrabenstrasse 24
72141 Walddorfhäslach
Telefon +49 (0) 7127 23 93 00
Telefax +49 (0) 7127 23 93 20
info.de@hubacontrol.com

Huba Control SA
Succursale France

Rue Lavoisier
Technopôle Forbach-Sud
57602 Forbach Cedex
Téléphone +33 (0) 387 847 300
Télécopieur +33 (0) 387 847 301
info.fr@hubacontrol.com

Huba Control AG
Vestiging Nederland

Hamseweg 20A
3828 AD Hoogland
Telefoon +31 (0) 33 433 03 66
Telefax +31 (0) 33 433 03 77
info.nl@hubacontrol.com

Huba Control AG
Branch Office United Kingdom

Unit 13 Berkshire House
County Park Business Centre
Shrivenham Road
Swindon Wiltshire SN1 2NR
Phone +44 (0) 1993 776667
Fax +44 (0) 1993 776671
info.uk@hubacontrol.com