

Durchflusssensor für flüssige Medien Typ 236

Flowsensor for Liquids type 236

Débitmètre pour liquides type 236

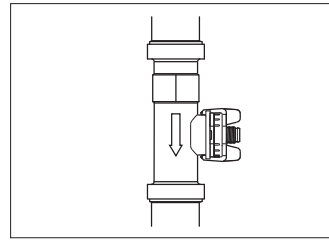
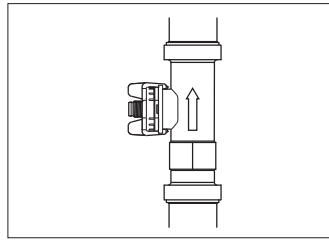
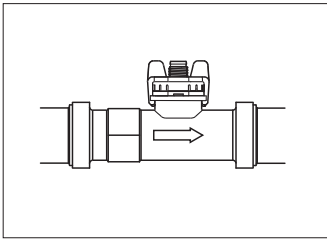

On Request
(No air bubble)

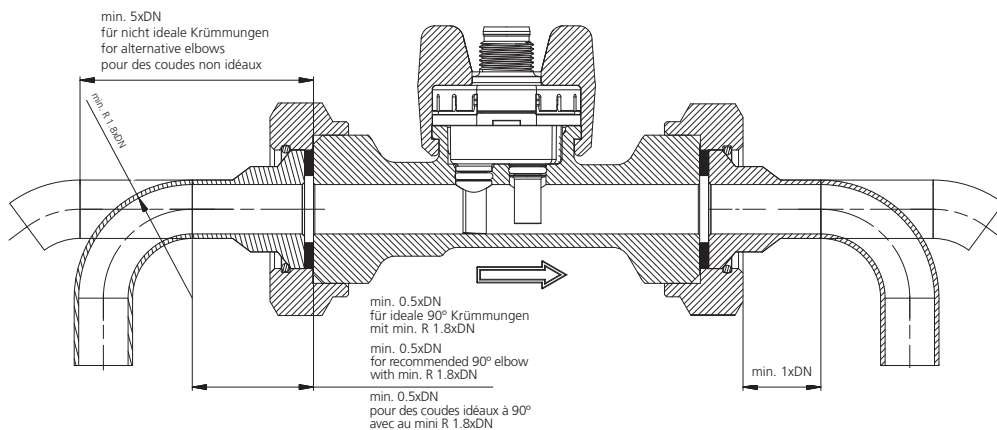
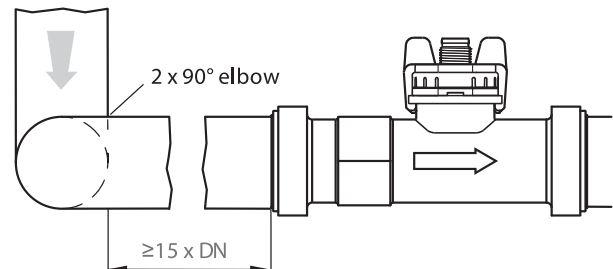
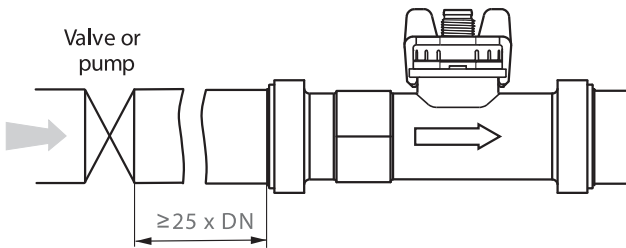
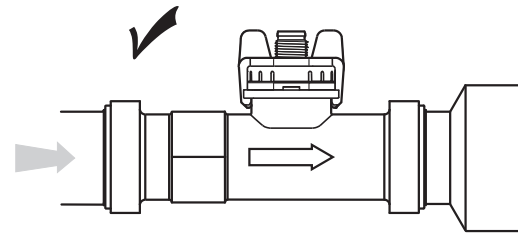
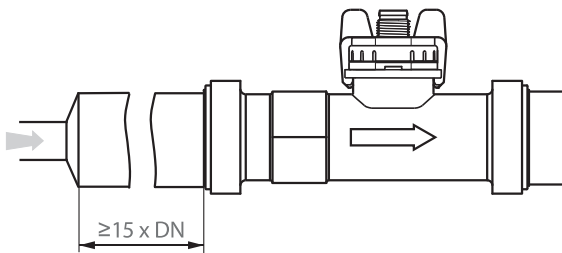
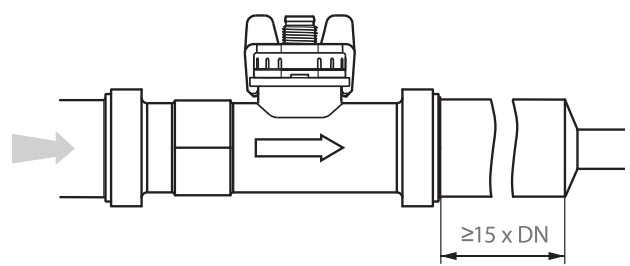
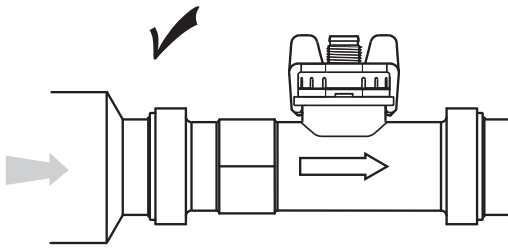

according EN 61326-2-3

Stressless mounting

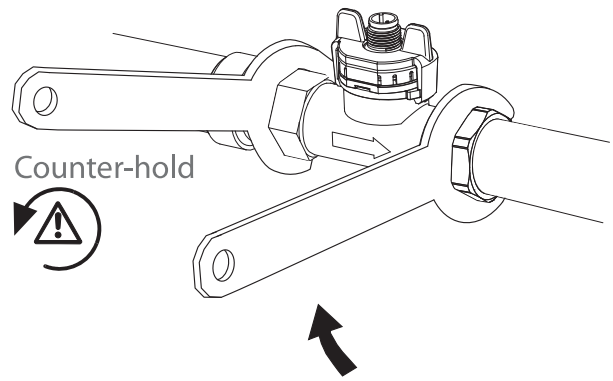
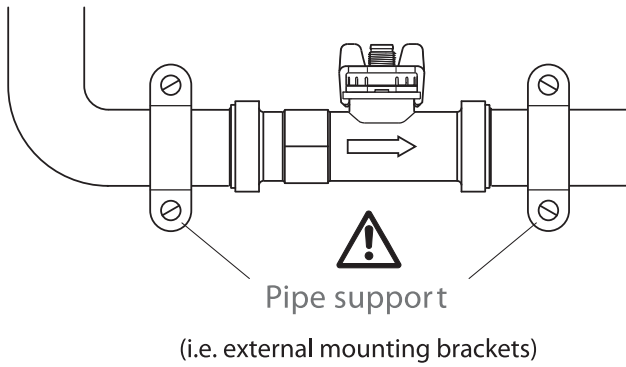

M12x1 ohne Temperaturmessung / M12x1 without temperature output / M12x1 sans sortie température 1

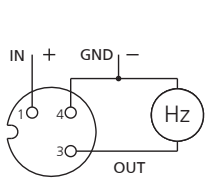

Frequenz Ausgang ungefiltert
Frequency output unfiltered
Sortie fréquence non filtrée

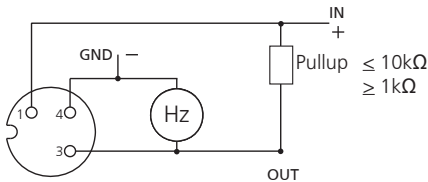

Frequenz Ausgang gefiltert, Impuls Ausgang
Frequency output filtered, pulse output
Sortie fréquence filtrée, sortie à impulsions

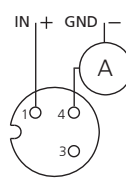

Strom Ausgang
Current output
Sortie courant

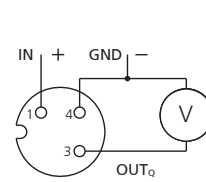

Spannung Ausgang
Voltage output
Sortie tension

M12x1 mit Temperaturmessung / M12x1 with temperature output / M12x1 avec sortie température 2

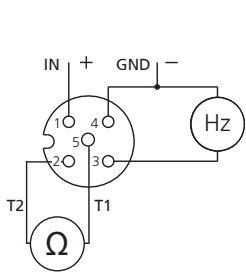

Frequenz Ausgang mit PT1000
Frequency output with PT1000
Sortie fréquence avec PT1000

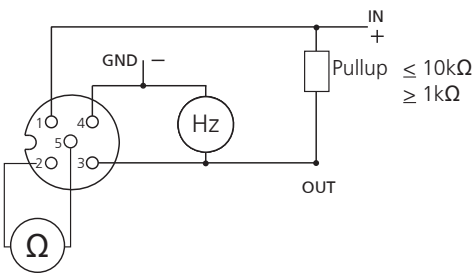

Frequenz Ausgang gefiltert, Impuls Ausgang
Frequency output filtered, pulse output
Sortie fréquence filtrée, sortie à impulsions

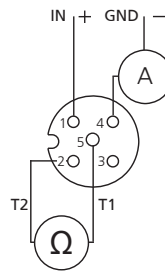

Strom Ausgang mit PT1000
Current output with PT1000
Sortie courant avec PT1000

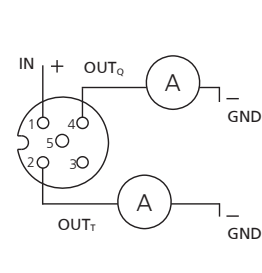

Strom Ausgang mit 4 ... 20 mA
Current output with 4 ... 20 mA
Sortie courant avec 4 ... 20 mA

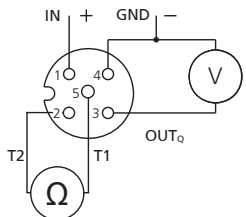

Spannung Ausgang mit PT1000
Voltage output with PT1000
Sortie tension avec PT1000

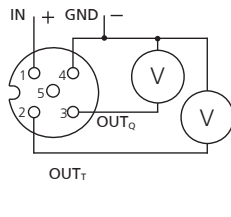

Spannung Ausgang mit 0 ... 10 V
Voltage output with 0 ... 10 V
Sortie tension avec 0 ... 10 V

Pin		Farbe / colour / couleur
1	1	braun / brown / brun
3		blau / blue / bleu
4		schwarz / black / noir
5		
1	2	braun / brown / brun
2		weiss / white / blanc
3		blau / blue / bleu
4		schwarz / black / noir
5		grau / gray / gris



Montage

Speisung durch SELV- oder Klasse 2-Spannungsversorgung.

Qualifiziertes Personal

Geräte dieser Sensorserie dürfen nur von qualifiziertem Personal und ausschließlich entsprechend der technischen Daten verwendet werden. Qualifiziertes Personal sind Personen, die mit der Aufstellung, Montage, Inbetriebnahme und Betrieb dieses Gerätes vertraut sind und die über eine ihrer Tätigkeit entsprechende Qualifikation verfügen.

Mounting

Supply from SELV or class 2 source.

Qualified staff

The devices may only be installed, connected, set-up and operated by qualified staff and in compliance with the technical specifications. Qualified staff is defined as persons, who are familiar with set-up, mounting, start-up and operation of this device and who possess a recognized degree or certificate of appropriate professional training.

Montage

Alimentation uniquement par SELV ou issu d'une source de class 2.

Personnel qualifié

Les appareils de cette série de transmetteurs ne doivent être utilisés que par du personnel qualifié et uniquement suivant les données techniques. Par personnel qualifié on entend les personnes qui connaissent bien l'installation, le montage, la mise en service et le fonctionnement de cet appareil, et qui disposent d'une qualification appropriée.