



Drucktransmitter

Huba Control

Relativ- und Absolutdrucktransmitter Typ 528



Die kompakten Drucktransmitter der Typenreihe 528 basieren auf der von Huba Control entwickelten und seit über 20 Jahren millionenfach eingesetzten Keramik-Technologie.

Diese Drucktransmitter eignen sich für den Einsatz in unterschiedlichsten Industrieanwendungen.

Druckbereich
-1 ... 0 – 60 bar

- + Kompakte und robuste Bauart
- + Geringste Temperatureinflüsse auf die Genauigkeit
- + Stecker-Variantenvielfalt
- + Zeitsparende, schnelle kundenseitige Kabelmontage durch Kabel-Schnellverschraubung

Technische Daten

Druckbereich

Relativ	-1 ... 0 – 60 bar
Absolut	0 ... 1 – 16 bar

Einsatzbedingungen

Medium	Flüssigkeiten und Gase	
Temperatur	Medium	FPM -15 ... +125 °C (E) -15 ... +120 °C
		EPDM -40 ... +125 °C (E) -30 ... +120 °C
		NBR -20 ... +100 °C
		MVQ -40 ... +125 °C (E) -30 ... +120 °C
		FPM -40 ... +125 °C (E) -30 ... +120 °C
	Umgebung	-30 ... +85 °C (E) -25 ... +85 °C
	Lagerung	-50 ... +100 °C
Zulässige Überlast / Berstdruck	≤ 4 bar	3.0 x FS
	> 4 bar	2.5 x FS

Materialien

Gehäuse	Edelstahl 1.4404 / AISI 316L	
Steckeraufnahme	Polyarylamid 50% GF UL 94 V-0	
Materialien mit Medienkontakt	Druckanschluss	Edelstahl 1.4404 / AISI 316L
	Messelement	PVDF
	Dichtmaterial	Keramik Al ₂ O ₃ (96%) FPM, EPDM, NBR, MVQ

Elektrische Daten

2-Leiter	Ausgang	Speisung	Bürde	Stromaufnahme
	4 ... 20 mA (E)	7 ... 33 VDC	< $\frac{\text{Nennspannung} - 7V}{0.02A}$ [Ohm]	< 23 mA
3-Leiter	4 ... 20 mA	10 ... 30 VDC	< $\frac{\text{Nennspannung} - 10V}{0.02A}$ [Ohm]	< 23 mA
	0 ... 5 V	7 ... 33 VDC	>10 kOhm / < 100 nF	< 7 mA
	1 ... 6 V	8 ... 33 VDC	>10 kOhm / < 100 nF	< 7 mA
	0 ... 10 V	12 ... 33 VDC	>10 kOhm / < 100 nF	< 7 mA
	0 ... 10 V	12 ... 33 VDC / 24 VAC ± 15%	>10 kOhm / < 100 nF	< 7 mA
	ration. 10 ... 90% (E)	5 VDC ± 10%	>10 kOhm / < 100 nF	< 7 mA
	ration. 10 ... 90%	5 VDC ± 10%	>10 kOhm / < 100 nF	< 7 mA
Verpolungssicherheit	Kurzschluss- und verpolungssicher. Jeder Anschluss gegen jeden mit max. Speisespannung.			
Isolationsspannung				500 VDC

Dynamisches Verhalten

Ansprechzeit	< 2 ms, typ. 1 ms
Lastwechsel	< 100 Hz

Elektrischer Anschluss

Kabel-Schnellverschraubung mit oder ohne Kabel 1.5 / 2.0 / 3.0 / 5.0 m (PVC spez.)	IP 67	III
Stecker DIN EN 175301-803-A oder C (Industriestandard 9.4 mm)	IP 65	III
Stecker M12x1	IP 67	III
Stecker RAST 2.5 (nur 3-Leiter)	IP 00	III
Metri Pack 150 P2S Series	IP 67	III
Litzenanschluss	IP 65	III

Schutzart

Schutzklasse

Druckanschluss

Innengewinde	$\frac{7}{16}$ - 20 UNF	
	$\frac{1}{2}$ - 14 NPT	
	G $\frac{1}{4}$	mit O-Ring-Dichtung FPM (-30 ... +135 °C)
Aussengewinde	$\frac{7}{16}$ - 20 UNF	Dichtkonus 45°
	$\frac{1}{4}$ - 18 NPT	
	$\frac{7}{16}$ - 20 UNF	hinten dichtend SAE 4 mit O-Ring-Dichtung FPM (-20 ... +135 °C)
	G $\frac{1}{4}$, G $\frac{1}{2}$, G $\frac{3}{8}$	hinten dichtend ISO 1179-2 (DIN 3852-E) mit Profildichtring FPM (-30 ... +135 °C)
	G $\frac{1}{4}$	hinten dichtend und Manometer mit Profildichtring FPM (-30 ... +135 °C)
	R $\frac{1}{4}$	EN 10226
	G $\frac{1}{4}$, G $\frac{1}{2}$	hinten dichtend und Manometer (Kombi) mit Profildichtring FPM (-30 ... +135 °C)
	G $\frac{1}{4}$	hinten dichtend DIN 3852-2 Form A
	$\frac{1}{8}$ - 27 NPT	
	G $\frac{1}{8}$	vorne dichtend oder hinten dichtend und Manometer (Kombi) mit Profildichtring FPM (-30 ... +135 °C)
M10x1	hinten dichtend ISO 9974-2 (DIN 3852-E) mit Profildichtung FPM (-30 ... +135 °C)	
M20x1.5	vorne dichtend und Manometer (Kombi)	
G $\frac{1}{4}$, G $\frac{1}{2}$	vorne dichtend	

Einbaulage

Beliebig	Empfehlung: Druckanschluss nach unten.
----------	---

Prüfungen / Zulassungen

Elektromagnetische Verträglichkeit	CE-Konform gemäss EN 61326-2-3
Erhöhte Störfestigkeit	EN 50121-3-2
Schock nach IEC 68-2-27	100 g, 11 ms, Halbsinuskurve, alle 6 Richtungen, freier Fall aus 1 m auf Beton (6x)
Dauerschock nach IEC 68-2-29	40 g über 6 ms, 1000x alle 3 Richtungen.
Vibration nach IEC 68-2-6	20 g, 15 ... 2000 Hz, 15 ... 25 Hz mit Amplitude ± 15 mm, 1 Oktave / Minute alle 3 Richtungen, 50 Dauerbelastungen
UL	ANSI/UL 61010-1 gemäss E325110
Trinkwasserzulassung	NSF/ANSI 61/372 gemäss MH60087
EAC	

Explosionsschutz (E)

Eigensicherheit «i»	ration. 10 ... 90%	4 ... 20 mA
	Ex II 1/2 G Ex ia IIC T4 Ga/Gb	Ex II 1/2 G Ex ia IIC T4 Ga/Gb
EG-Baumusterprüfbescheinigung	Ex II 1/2 D Ex ia IIC T125°C Da/Db	Ex II 1/2 D Ex ia IIC T125°C Da/Db
	SEV 15 ATEX 0173	SEV 10 ATEX 0145
Anschluss an bescheinigte eigensichere ohmsche Stromkreise mit den Höchstwerten	Ui ≤ 15 VDC; Ii ≤ 200 mA; Pi ≤ 750 mW	Ui ≤ 30 VDC; Ii ≤ 100 mA; Pi ≤ 750 mW
Wirksame innere Induktivität und Kapazität bei Ausführungen mit Stecker-Variante EN 175301-803-A oder M12x1	Li = 0 nH; Ci ≤ 150 nF	Li = 0 nH; Ci = 0 nF
IECEX		SEV 16.0007

Gewicht

~ 90 g

Verpackung (auf Bestellung angeben)

Einzelverpackung in Kartons	Zubehör integriert
Mehrfachverpackung in Kartons (à 25 Stk.)	

Genauigkeit





Parameter	Einheit	
Kennlinie ¹⁾	% FS	± 0.3
Auflösung	% FS	0.1
Temperaturverhalten ²⁾	max. % FS/10K	± 0.2
Langzeitstabilität nach IEC EN 60770-1	max. % FS	± 0.25

Testbedingungen: 25 °C, 45% rF, Speisung 24 VDC

Variantenplan in bar

				1	2	3	4	5	6	7	8	9	10	11	
				528. X X X X X X X X X X X											
Druckbereich (Relativ) ³⁾	-1 ... 0 bar			9	0	1									
	0 ... 1 bar			9	1	1									
	0 ... 1.6 bar			9	1	2									
	0 ... 2.5 bar			9	1	4		0,4							
	0 ... 4 bar			9	1	5		0,4							
	0 ... 6 bar			9	1	7		0,4							
	0 ... 10 bar			9	3	0		0,4							
	0 ... 16 bar			9	3	1		0,4							
	0 ... 25 bar			9	3	2		0,4						1	
	0 ... 40 bar			9	3	3		0,4						1	
0 ... 60 bar			9	4	0		0,4						1		
Druckbereich (absolut) ³⁾	0 ... 1 bar			8	1	1									
	0 ... 1.6 bar			8	1	2									
	0 ... 2.5 bar			8	1	4									
	0 ... 4 bar			8	1	5									
	0 ... 6 bar			8	1	7									
	0 ... 10 bar			8	3	0									
0 ... 16 bar			8	3	1										
Dichtmaterial	FPM Fluor-Kautschuk	-15 ... +125 °C	(⊖) -15 ... +120 °C					0							
	EPDM Äthylen-Propylen-Kautschuk	-40 ... +125 °C	(⊖) -30 ... +120 °C					1							
	NBR Butadien-Acrylnitril-Kautschuk	-20 ... +100 °C						2							
	MVQ Silikon-Kautschuk	-40 ... +125 °C	(⊖) -30 ... +120 °C					3							
	FPM Fluor-Kautschuk	-40 ... +125 °C	(⊖) -30 ... +120 °C					5							
Ausführung	standard							0							
	für Sauerstoffanwendungen							0	1			1	1		
	mit Trinkwasserzulassung NSF 61							0	4			1	1		
Ausgang / Speisung	0 ... 5V	7 ... 33 VDC							1						
	1 ... 6V	8 ... 33 VDC							6						
	0 ... 10V	12 ... 33 VDC								2					
		12 ... 33 VDC	erhöhte Störfestigkeit							C	1,2,3				
		12 ... 33 VDC / 24 VAC ±15% (M12x1, Metri Pack, RAST, Litzen nicht möglich)								8					
	ration. 10 ... 90%	5VDC ±10%								7					
		5VDC ±10%	Ex-Schutz					0,4	9	1,3			1		
	4 ... 20 mA	7 ... 33 VDC								3					
		7 ... 33 VDC	erhöhte Störfestigkeit (Litzenanschluss nicht möglich)							A					
		10 ... 30 VDC	Ex-Schutz					0,4	4	1,3			1		
Elektrischer Anschluss	Stecker ⁴⁾	DIN EN 175301-803-A										1			
		DIN EN 175301-803-C (Industriestandard 9.4 mm)										2			
		M12x1 2L: IN=1 / OUT=3 3L: IN=1 / OUT=4 / GND=3											3		
		M12x1 2L: IN=1 / OUT=4 3L: IN=1 / OUT=3 / GND=4											M		
		M12x1 2L: IN=1 / OUT=2 3L: IN=1 / OUT=2 / GND=3											P		
		RAST 2.5						0,4	7	4					
	Litzenanschluss	Metri Pack 150 P2S Series						0,4		5					
		.80 ±10 mm								6					
		290 ±10 mm								7					
		480 ±10 mm								8					
		730 ±10 mm								9					
	Kabel-Schnellverschraubung	ohne Kabel								0					
		mit Kabel 1.5 m								L					
		mit Kabel 2.0 m								N					
		mit Kabel 3.0 m								Q					
Druckanschluss ³⁾	Innengewinde	7/16"-20 UNF										K	1		
		1/2"-14 NPT										D	1		
		G 1/4 mit O-Ring-Dichtung FPM										1	1		
	Aussengewinde	7/16"-20 UNF											2	1	
		1/4"-18 NPT											3	1	
		G 1/4 hinten dichtend ISO 1179-2 (DIN 3852-E) mit Profildichtring FPM											4	1	
		G 1/4 hinten dichtend und Manometer mit Profildichtring FPM											5	1	1
		R 1/4 nach EN 10226											7	1	
		G 1/2 hinten dichtend und Manometer mit Profildichtring FPM						0,1					8	1	
		7/16"-20 UNF hinten dichtend SAE 4 mit O-Ring-Dichtung FPM						0,1					G	1	
		1/8"-27 NPT											A	1	
		G 1/8 vorne dichtend											M	1	
		G 1/8 hinten dichtend ISO 1179-2 (DIN 3852-E) mit Profildichtring FPM						0,1					H	1	
		G 1/4 vorne dichtend											J		
		G 1/4 hinten dichtend DIN 3852-2 Form A ⁵⁾											S	1	
G 1/2 hinten dichtend ISO 1179-2 (DIN 3852-E) mit Profildichtring FPM						0,1					C	1			
M10x1 hinten dichtend ISO 9974-2 (DIN 3852-E) mit Profildichtung FPM						0,1					F	1			
M20x1.5 vorne dichtend und Manometer (Kombi)											E	1			
G 1/2 vorne dichtend											9				
Druckspitzenblende	ohne												1		
	mit												2		
Material Druckanschluss	Edelstahl 1.4404 / AISI 316 L													1	
	PVDF Aussengewinde ⁶⁾	vorne dichtend für G 1/4, G 1/2	≤ 16 bar									J,9	1	2	
Abweichung (optional)	W einsetzen und Bereich auf Bestellung angeben (Bsp. W0... + 3bar/OUT0...5V)													W	

¹⁾ typisch; max. 0.5% FS (inkl. Nullpunkt, Endwert, Linearität, Hysterese und Reproduzierbarkeit) ²⁾ -15 ... +85 °C ³⁾ Andere Druckbereiche und Druckanschlüsse auf Anfrage
⁴⁾ Lieferung ohne Steckdose ⁵⁾ ohne UL-Zulassung ⁶⁾ Mediumtemperatur -15 ... +85 °C





Variantenplan in psi			1	2	3	4	5	6	7	8	9	10	11			
			528.	X	X	X	X	X	X	X	X	X	X			
Druckbereich (Relativ) ¹⁾	-30 ... 0"hg		9	B	0											
	0 ... 15 psi		9	B	1											
	0 ... 20 psi		9	B	2											
	0 ... 30 psi		9	B	4		0,4									
	0 ... 60 psi		9	B	5		0,4									
	0 ... 100 psi		9	B	7		0,4									
	0 ... 150 psi		9	C	0		0,4									
	0 ... 200 psi		9	C	1		0,4									
	0 ... 300 psi		9	C	2		0,4						1			
	0 ... 500 psi		9	C	3		0,4						1			
	0 ... 750 psi		9	D	0		0,4					1				
Druckbereich (absolut) ¹⁾	0 ... 15 psi		8	B	1											
	0 ... 20 psi		8	B	2											
	0 ... 30 psi		8	B	4											
	0 ... 60 psi		8	B	5											
	0 ... 100 psi		8	B	7											
	0 ... 150 psi		8	C	0											
	0 ... 200 psi		8	C	1											
Dichtmaterial	FPM Fluor-Kautschuk	-15 ... +125 °C	()	-15 ... +120 °C				0								
	EPDM Äthylen-Propylen-Kautschuk	-40 ... +125 °C	()	-30 ... +120 °C				1								
	NBR Butadien-Acrylnitril-Kautschuk	-20 ... +100 °C						2								
	MVQ Silikon-Kautschuk	-40 ... +125 °C	()	-30 ... +120 °C				3								
	FPM Fluor-Kautschuk	-40 ... +125 °C	()	-30 ... +120 °C				5								
Ausführung	standard							0								
	für Sauerstoffanwendungen							0	1			1	1			
	mit Trinkwasserzulassung NSF 61							0	4			1	1			
Ausgang / Speisung	0 ... 5V	7 ... 33 VDC									1					
	1 ... 6V	8 ... 33 VDC									6					
	0 ... 10V	12 ... 33 VDC										2				
		12 ... 33 VDC	erhöhte Störfestigkeit									C	1,2,3			
		12 ... 33 VDC / 24 VAC ±15%	(M12x1, Metri Pack, RAST, Litzen nicht möglich)									8				
	ratiom. 10 ... 90%	5VDC ±10%										7				
		5VDC ±10%	Ex-Schutz						0,4	9	1,3			1		
	4 ... 20 mA	7 ... 33 VDC										3				
		7 ... 33 VDC	erhöhte Störfestigkeit (Litzenanschluss nicht möglich)									A				
		10 ... 30 VDC	Ex-Schutz						0,4	4	1,3			1		
Elektrischer Anschluss	Stecker ²⁾	DIN EN 175301-803-A										1				
		DIN EN 175301-803-C (Industriestandard 9.4 mm)											2			
		M12x1	2L: IN=1 / OUT=3	3L: IN=1 / OUT=4 / GND=3										3		
		M12x1	2L: IN=1 / OUT=4	3L: IN=1 / OUT=3 / GND=4											M	
		M12x1	2L: IN=1 / OUT=2	3L: IN=1 / OUT=2 / GND=3												P
		RAST 2.5							0,4	7			4			
	Litzenanschluss	Metri Pack 150 P2S Series							0,4				5			
		80 ±10 mm												6		
		290 ±10 mm													7	
		480 ±10 mm														8
		730 ±10 mm														9
	Kabel-Schnellverschraubung	ohne Kabel													0	
		mit Kabel 1.5 m													L	
		mit Kabel 2.0 m													N	
		mit Kabel 3.0 m														Q
mit Kabel 5.0 m															R	
Druckanschluss ¹⁾	Innengewinde	7/16 - 20 UNF												K	1	
		1/2 - 14 NPT													D	1
		G 1/4 mit O-Ring-Dichtung FPM													1	1
	Aussengewinde	7/16 - 20 UNF													2	1
		1/4 - 18 NPT													3	1
		G 1/4 hinten dichtend ISO 1179-2 (DIN 3852-E) mit Profildichtring FPM													4	1
		G 1/4 hinten dichtend und Manometer mit Profildichtring FPM													5	1
		R 1/4 nach EN 10226													7	1
		G 1/2 hinten dichtend und Manometer mit Profildichtring FPM							0,1						8	1
		7/16 - 20 UNF hinten dichtend SAE 4 mit O-Ring-Dichtung FPM							0,1						G	1
		1/8 - 27 NPT													A	1
		G 1/8 vorne dichtend													M	1
		G 1/8 hinten dichtend ISO 1179-2 (DIN 3852-E) mit Profildichtring FPM							0,1						H	1
		G 1/4 vorne dichtend													J	
		G 1/4 hinten dichtend DIN 3852-2 Form A ³⁾													S	1
G 1/2 hinten dichtend ISO 1179-2 (DIN 3852-E) mit Profildichtring FPM							0,1						C	1		
M10x1 hinten dichtend ISO 9974-2 (DIN 3852-E) mit Profildichtung FPM							0,1						F	1		
M20x1.5 vorne dichtend und Manometer (Kombi)													E	1		
	G 1/2 vorne dichtend													9		
Druckspitzenblende	ohne														1	
	mit														2	
Material Druckanschluss	Edelstahl 1.4404 / AISI 316 L															
	PVDF Aussengewinde ⁴⁾	vorne dichtend für G 1/4, G 1/2												J,9	1	
Abweichung (optional)	W einsetzen und Bereich auf Bestellung angeben (Bsp. W0... + 16psi/OUT0...5V)														W	

¹⁾ Andere Druckbereiche und Druckanschlüsse auf Anfrage

²⁾ Lieferung ohne Steckdose

³⁾ ohne UL-Zulassung

⁴⁾ Mediumtemperatur -15 ... +85 °C

Variantenplan in MPa				1	2	3	4	5	6	7	8	9	10	11	
				528.	X	X	X	X	X	X	X	X	X	X	
Druckbereich (Relativ) ¹⁾	-0.1 ... 0 MPa			9	G	0									
	0 ... 0.1 MPa			9	G	1									
	0 ... 0.16 MPa			9	G	2									
	0 ... 0.25 MPa			9	G	4			0,4						
	0 ... 0.4 MPa			9	G	5			0,4						
	0 ... 0.6 MPa			9	G	7			0,4						
	0 ... 1 MPa			9	H	0			0,4						
	0 ... 1.6 MPa			9	H	1			0,4						
	0 ... 2.5 MPa			9	H	2			0,4					1	
	0 ... 4 MPa			9	H	3			0,4					1	
Druckbereich (absolut) ¹⁾	0 ... 0.1 MPa			9	K	0			0,4					1	
	0 ... 0.16 MPa			8	G	1									
	0 ... 0.25 MPa			8	G	2									
	0 ... 0.4 MPa			8	G	4									
	0 ... 0.6 MPa			8	G	5									
	0 ... 1 MPa			8	G	7									
	0 ... 1.6 MPa			8	H	0									
Dichtmaterial	FPM	Fluor-Kautschuk	-15 ... +125 °C	()	-15 ... +120 °C			0							
	EPDM	Äthylen-Propylen-Kautschuk	-40 ... +125 °C	()	-30 ... +120 °C			1							
	NBR	Butadien-Acrylnitril-Kautschuk	-20 ... +100 °C					2							
	MVQ	Silikon-Kautschuk	-40 ... +125 °C	()	-30 ... +120 °C			3							
	FPM	Fluor-Kautschuk	-40 ... +125 °C	()	-30 ... +120 °C			5							
Ausführung	standard							0							
	für Sauerstoffanwendungen							0	1				1	1	
	mit Trinkwasserzulassung NSF 61							0	4				1	1	
Ausgang / Speisung	0 ... 5 V	7 ... 33 VDC								1					
	1 ... 6 V	8 ... 33 VDC								6					
	0 ... 10 V	12 ... 33 VDC									2				
		12 ... 33 VDC	erhöhte Störfestigkeit								C	1,2,3			
		12 ... 33 VDC	/ 24 VAC ±15% (M12x1, Metri Pack, RAST, Litzen nicht möglich)								8				
	ratiom. 10 ... 90%	5VDC ±10%									7				
		5VDC ±10%	Ex-Schutz						0,4	9	1,3			1	
	4 ... 20 mA	7 ... 33 VDC									3				
		7 ... 33 VDC	erhöhte Störfestigkeit (Litzenanschluss nicht möglich)								A				
		10 ... 30 VDC	Ex-Schutz						0,4	4	1,3			1	
Elektrischer Anschluss	Stecker ²⁾	DIN EN 175301-803-A											1		
		DIN EN 175301-803-C (Industriestandard 9.4 mm)												2	
		M12x1	2L: IN=1 / OUT=3	3L: IN=1 / OUT=4 / GND=3										3	
		M12x1	2L: IN=1 / OUT=4	3L: IN=1 / OUT=3 / GND=4										M	
		M12x1	2L: IN=1 / OUT=2	3L: IN=1 / OUT=2 / GND=3										P	
		RAST 2.5							0,4	7		4			
	Litzenanschluss	Metri Pack 150 P2S Series							0,4		5				
		80 ±10 mm									6				
		290 ±10 mm									7				
		480 ±10 mm									8				
		730 ±10 mm									9				
	Kabel-Schnellverschraubung	ohne Kabel									0				
		mit Kabel 1.5 m									L				
		mit Kabel 2.0 m									N				
		mit Kabel 3.0 m									Q				
mit Kabel 5.0 m									R						
Druckanschluss ¹⁾	Innengewinde	7/16 - 20 UNF											K	1	
		1/2 - 14 NPT												D	1
		G 1/4 mit O-Ring-Dichtung FPM												1	1
	Aussengewinde	7/16 - 20 UNF												2	1
		1/4 - 18 NPT												3	1
		G 1/4 hinten dichtend ISO 1179-2 (DIN 3852-E) mit Profildichtring FPM												4	1
		G 1/4 hinten dichtend und Manometer mit Profildichtring FPM												5	1
		R 1/4 nach EN 10226												7	1
		G 1/2 hinten dichtend und Manometer mit Profildichtring FPM							0,1					8	1
		7/16 - 20 UNF hinten dichtend SAE 4 mit O-Ring-Dichtung FPM							0,1					G	1
		1/8 - 27 NPT												A	1
		G 1/8 vorne dichtend												M	1
		G 1/8 hinten dichtend ISO 1179-2 (DIN 3852-E) mit Profildichtring FPM							0,1					H	1
		G 1/4 vorne dichtend												J	
		G 1/4 hinten dichtend DIN 3852-2 Form A ³⁾												S	1
G 1/2 hinten dichtend ISO 1179-2 (DIN 3852-E) mit Profildichtring FPM							0,1					C	1		
M10x1 hinten dichtend ISO 9974-2 (DIN 3852-E) mit Profildichtung FPM							0,1					F	1		
M20x1.5 vorne dichtend und Manometer (Kombi)												E	1		
G 1/2 vorne dichtend												9			
Druckspitzenblende	ohne												1		
	mit												2		
Material Druckanschluss	Edelstahl 1.4404 / AISI 316 L														
	PVDF Aussengewinde ⁴⁾ vorne dichtend für G 1/4, G 1/2 ≤ 1.6 MPa												J,9	1	
Abweichung (optional)	W einsetzen und Bereich auf Bestellung angeben (Bsp. W0... + 0.3MPa/OUT0...5V)													W	

¹⁾ Andere Druckbereiche und Druckanschlüsse auf Anfrage

²⁾ Lieferung ohne Steckdose

³⁾ ohne UL-Zulassung

⁴⁾ Mediumtemperatur -15 ... +85 °C

Steckdose Kabel-Schnellverschraubung	117312
Steckdose DIN EN 175301-803-A mit Dichtung	103510
Steckdose DIN EN 175301-803-C mit Dichtung	104244
Winkel-Kabeldose für Stecker M12x1	106975
Winkel-Kabeldose für Stecker M12x1 mit Kabel 2 m	114604
Gerade-Kabeldose für Stecker M12x1	114570
Gerade-Kabeldose für Stecker M12x1 mit Kabel 2m	114605
Befestigungswinkel mit Schraube	118716
Kühlkörper mit Aussengewinde G 1/2 vorne dichtend - Innengewinde G 1/2	105631
Kühlkörper mit Aussengewinde G 1/2 vorne dichtend - Innengewinde G 1/4	105073
Kühlkörper mit Aussengewinde G 1/4 vorne dichtend - Innengewinde G 1/4	105074
Kalibrierzertifikat	104551

Befestigungswinkel mit Schraube

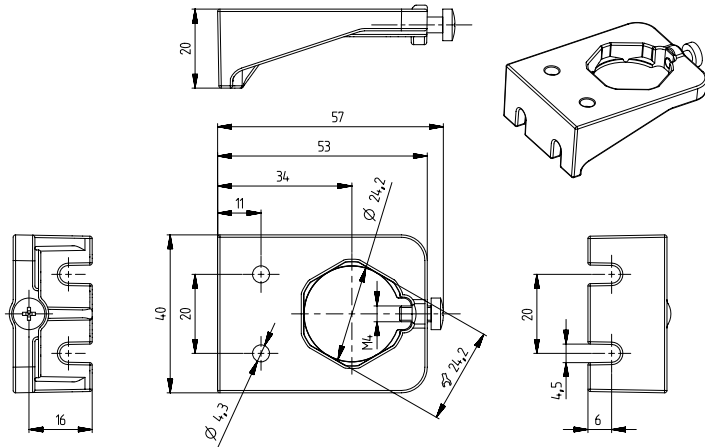

Kühlkörper

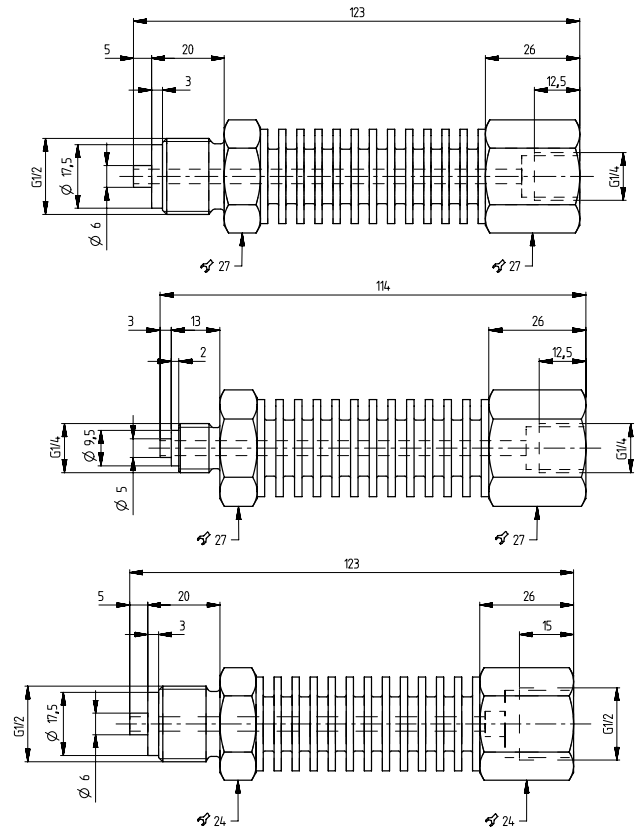

Abmessungen in mm

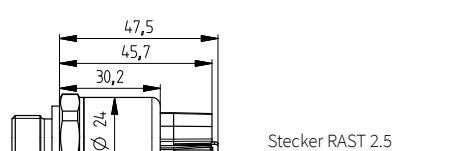
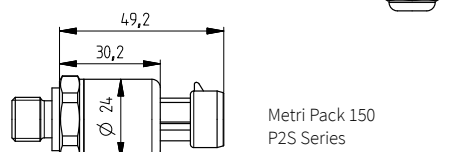
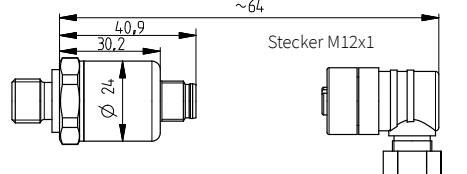
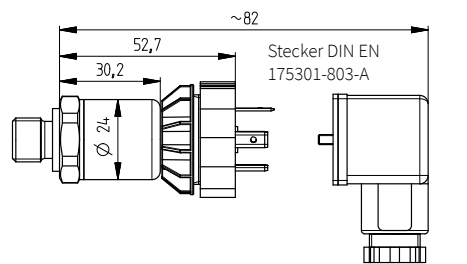
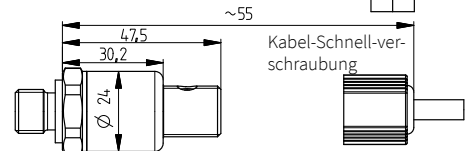
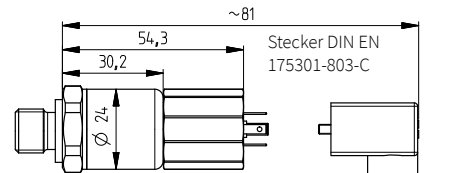
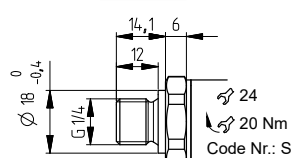
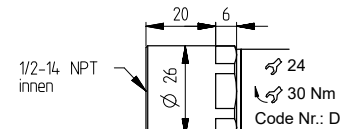
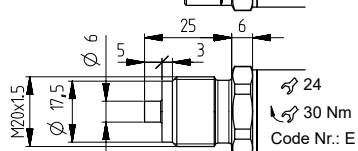
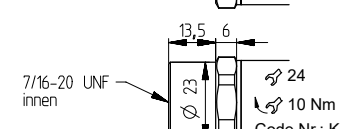
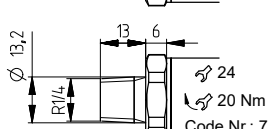
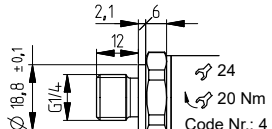
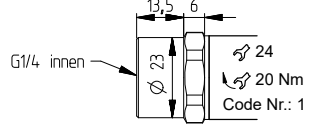
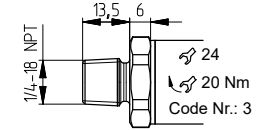
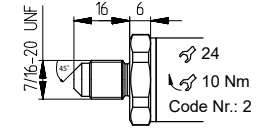
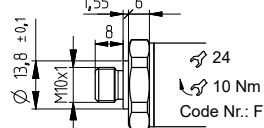
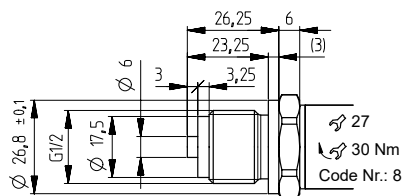
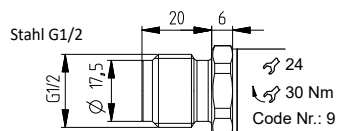
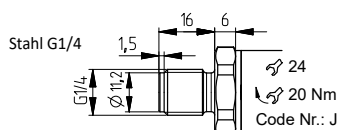
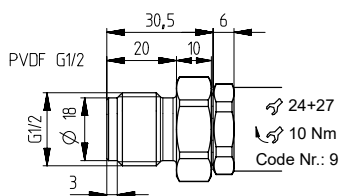
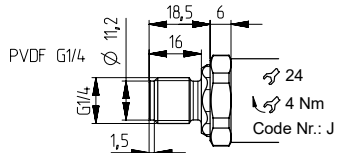
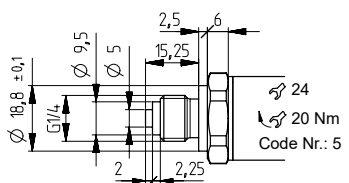
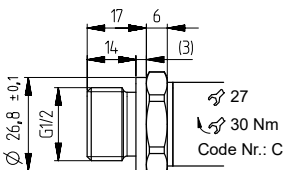
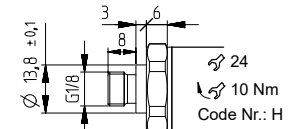
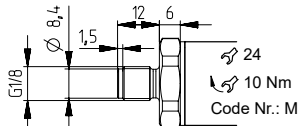
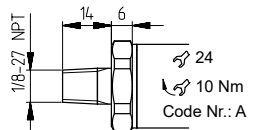
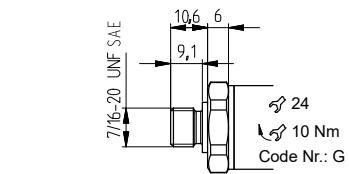

Elektrische Anschlüsse

2-Leiter

Stecker DIN EN 175301-803-A oder C

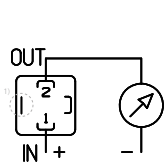

1 (IN) 2 (OUT)

Kabel-Schnellverschraubung

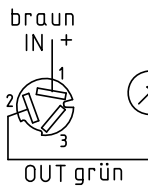

1 (IN) 2 (OUT)

Stecker M12x1

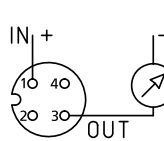

1 (IN) 3 (OUT)

Stecker M12x1

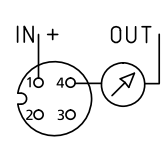

1 (IN) 4 (OUT)

Stecker M12x1

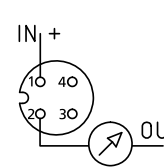

1 (IN) 2 (OUT)

Metri Pack 150 P2S Serie

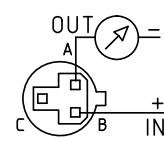

B (IN) A (OUT)

Litzenanschluss

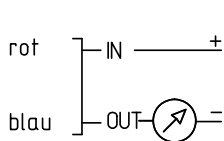

3-Leiter

Stecker DIN EN 175301-803-A oder C

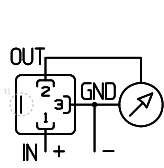

1 (IN) 2 (OUT) 3 (GND)

Kabel-Schnellverschraubung

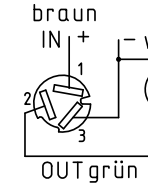

1 (IN) 2 (OUT) 3 (GND)

Stecker M12x1

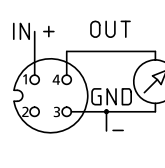

1 (IN) 4 (OUT) 3 (GND)

Stecker M12x1

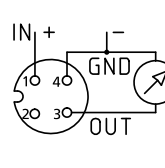

1 (IN) 3 (OUT) 4 (GND)

Stecker M12x1

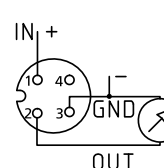

1 (IN) 2 (OUT) 3 (GND)

Metri Pack 150 P2S Serie

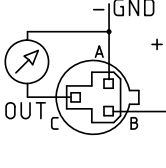

B (IN) C (OUT) A (GND)

Litzenanschluss

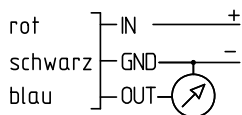

Stecker RAST 2.5

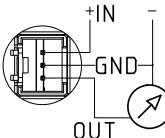

Geräteausführung mit Explosionsschutz: 4 ... 20 mA Der Erdungsanschluss ist mit dem Gehäuse des Drucktransmitters leitend verbunden.

Stecker DIN EN 175301-803-A

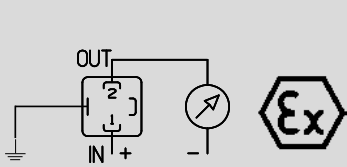

1 (IN) 2 (OUT) ↓

Stecker M12x1

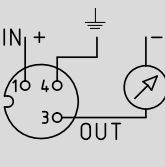

1 (IN) 3 (OUT) 4 (↓)

Geräteausführung mit Explosionsschutz: ratiom. 10 ... 90% Das Elektronik-GND ist über einen 1MΩ Widerstand mit dem Gehäuse des Drucktransmitters verbunden.

Stecker DIN EN 175301-803-A

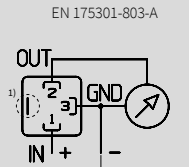

1 (IN) 2 (OUT) 3 (GND)

Stecker M12x1

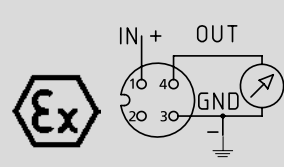

1 (IN) 3 (GND) 4 (OUT)

¹⁾ Nicht mit dem Transmittergehäuse verbunden

Huba Control AG

Industriestrasse 17
5436 Würenlos, Schweiz
Tel. +41 56 436 82 00
info.ch@hubacontrol.com

Huba Control AG

Zweigniederlassung Deutschland
Schlattgrabenstrasse 24
72141 Walddorfhäslach, Deutschland
Tel. +49 7127 2393 00
info.de@hubacontrol.com



Beratung in Ihrer Region
hubacontrol.com/de/weltweit

